



Leisegang Colposcopes and Accessories

Instructions for Use

English



All rights reserved. No part of this work may be reproduced in any form without written permission from CooperSurgical, Inc.

Table of Contents

Table of Contents

1	Important General References	4
1.1	Appropriate Use	4
1.1.1	Indications for Use	4
1.1.2	Contraindications	4
1.2	Symbols	5
1.3	How to read these Operating Instructions	5
2	Important Notes on Safety	6
2.1	List of Warnings	6
3	Certifications	7
3.1	CE Certification	7
3.2	UL Certification	7
4	Short Product Overview	8
5	Guarantee	10
6	Colposcopes	11
6.1	Equipment Overview, Installation and Operation	11
6.2	Scope of Delivery and Testing of the Supplied Goods	11
6.3	Standard Colposcopes	12
6.4	OptiK™ Model 2 (3MTL LED, 3MVCL LED USB)	13
6.4.1	Camera Adapter	14
6.5	General Adjustments	15
6.5.1	Rough Height Adjustment	15
6.5.2	Vertical and Horizontal Fine Adjustment	16
6.5.3	Compensation of Ametropia	16
6.5.4	Drum Magnification Dial	16
6.5.5	Focusing the Leisegang Colposcope	17
6.5.6	Green Filter	17
6.6	Do-It-Yourself Troubleshooting	18
6.6.1	Fine Height Adjustment	18
6.6.2	Hold Adjustment for Fine Focus	19
6.6.3	Fuses	19
7	Stands	20
7.1	Swing Stand	20
7.1.1	Swing Stand Assembly	21
7.2	The Balance-o-Matic Stand	21
7.2.1	Balance-o-Matic Stand Assembly	22
7.3	Tilt Stand and Upright Stand (Roller Base)	23
7.4	Installations	25
7.4.1	Installation of Swing Stand on Mobile 5-Wheel Roller Base	25
7.4.2	The Balance-o-Matic Stand on Mobile 5-Wheel Roller Base	26
8	Power Supply	27
8.1	LED-Lighting	28

9	Accessories	29
9.1	Video Adapters	29
9.1.1	Mounting Video Adapters	29
9.2	Camera	30
10	Care and Maintenance	31
10.1	Disinfection	31
11	Replacement Wear Parts and Technical Service	33
11.1	Technical Service	33
11.2	Spare and Worn Parts	33
11.2.1	Lamp Change	33
11.2.2	Fuses	33
12	Technical Data and Notes on Safety	34
12.1	EMC - Electromagnetic Compatibility	34
12.2	Control and Maintenance	34
12.3	Returns, Complaints	34
13	Technical Data	35
13.1	Type Plates	35
13.1.1	Type Plate Colposcope Head	35
13.1.2	Type Plate Power Supply	36
13.2	Classification	36
13.3	Safety Class	36
13.4	General	37
13.5	Devices with magnification 3.75x/7.5x/15x	37
13.6	Environment Conditions	38
13.7	Dimensions and Weights	38
13.8	Electrical Connections	39
13.9	Power Consumption	39
13.10	Lamps	39
13.11	LED Light Specification	39
13.12	Leisegang Colposcopes EMC Compliance Information	39
13.13	Electromagnetic compatibility	40
Table 1	Guidance and Manufacturers Declaration-Electromagnetic Radiation	40
Table 2	Guidance and Manufacturers Declaration Electromagnetic Immunity	41
Table 3	Guidance and Manufacturers Declaration Electromagnetic Immunity	42
Table 4	Recommended Separation Distance	43
13.14	Model number	44

Important General References

1 Important General References

Device Description

The Cooper Surgical Leisegang Colposcopes and accessories are optical devices designed for non contact visualization of the tissues of the cervix, vulva, vagina, and anogenital areas. Depending on the model and/or mode selected, they provide direct visual, photographic, and/or high resolution color imaging of the selected area.

1.1 Appropriate Use

Only Leisegang accessories, bases, sources of light and camera equipment may be utilized with Leisegang colposcopes.

Restrictions, which are stipulated in the Instructions for Use, are to be considered.

The device is designed for application in medical practices and/or clinics. The device is not intended to be used in locations with MRI, CT, diathermy, RFID, and electromagnetic security systems such as metal detectors.

Colposcopes should only be operated only by those persons who have been instructed in the expert handling of the device.

The proper installation and maintenance of the device are vital prerequisites before using the colposcope. The user should check the functional stability and proper condition of the device before every procedure.

1.1.1 Indications for Use

The Cooper Surgical Leisegang Colposcope Systems are intended for the magnified viewing of the tissues of the vagina, cervix, and external genitalia in order to assist doctors in diagnosing abnormalities such as lesions or cancer and selecting areas for biopsy.

The images from Cooper Surgical Leisegang Colposcope Systems may be viewed directly and/or on a color monitor (if so equipped). The Cooper Surgical Leisegang Colposcope Systems are intended for use in hospitals, clinics, and doctor's offices.













1.1.2 Contraindications

The Cooper Surgical Leisegang Colposcope is a device for viewing the body from a distance and is not intended for patient contact. Because of this there are no contraindications for use of a Colposcope.



Federal Law (USA) restricts this device to the sale by, or on the order of, a Physician!



1.2 Symbols

Symbol	Meaning	Symbol	Meaning
	Manufacturers address		Consult accompanying documents / Instructions for use
	Protection Class II		Date of Manufacture
	Type B applied part	IP20	Ingress protection rating
	Serial number of the product		Symbol indicates that the device should be sent to the special agencies according to local regulations for separate collection after its useful life
	Authorized European Representative		Model or part number of the product
	Quantity		Lot number
	Electromagnetic interference can occur in the vicinity of devices carrying this symbol		The product complies with US and Canadian safety requirements.

1.3 How to read these Operating Instructions

These instructions are structured around the operation of the colposcope, from assembly to the finished system. Basic troubleshooting information is also provided. Our goal is to make these instructions easily understandable and technically feasible.

The instruction content follows the structure of a colposcope: head, base, accessories, electrics, maintenance and safety. The inside edge of each page is exclusively reserved for important key words, symbols and provides sufficient space for your personal notes. Symbol meanings are as follows:

Symbol	Meaning
	Warning: Important notes on safety. Pay close attention to the information and details provided here, in order to avoid personal injury or device damage.
	References: Here, reference is made to certain behavior and procedures during the installation and adjustment of the device or individual device subassemblies, such as the change of light intensities, filter insertions, fuse replacement, etc.
	Installation: The delivery of the goods dispatched from Leisegang always includes the tools needed for the installation, such as screwdrivers, Allen keys, etc.

2 Important Notes on Safety



Please read this chapter first!

Before you begin using the colposcope, please become familiar with the following safety regulations and keep these in mind while using the device.

2.1 List of Warnings

1. Light Emitting Diode (LED) colposcopes are Safety Class II products and DO NOT require grounded power cords or outlets.
2. Do not use extension cords.
3. Never adjust or cover over the transformers or other subassemblies. This can lead to overheating and damage to the device.
4. Use only an authorized Leisegang base with your Leisegang colposcope.
5. Do not hang any additional objects on the colposcope or on parts of the base.
6. Do not lean on the device.
7. Do not operate the device in an explosive endangered environment.
8. Defective cables or plugs can cause electrical accidents and fires. Replace defective cables immediately or call an authorized technician.
9. Do not use power supply units with damaged cases. Contact CooperSurgical for a replacement.
10. The mains cable (wired plug) should never be removed at the cable connection end, but always at the plug socket only.
11. Before connecting the power supply to the device, confirm that the mains voltage and frequency of the wall plug socket agree with the information on the colposcope label.
12. Do not roll the device over deep-pile carpets or over objects on the floor (cables, hoses).
13. Never set up or operate the device on rough or tilted surfaces.
14. Except for the components described in these Instructions for Use, the device may be opened exclusively by CooperSurgical / Leisegang trained personnel only, since high-voltage live parts are present in the device or in the subassemblies.
15. CooperSurgical / Leisegang is not liable for damages resulting from improper use of their products or contraventions against safety notes mentioned above.
16. Disposal: Devices produced by CooperSurgical / Leisegang and defective parts as well must be disposed of professionally only according to the valid laws and standards in the operator's country.
17. No modification of this equipment is allowed.
18. No Customer serviceable parts. Only replacement of eyepiece rings, light guides fuses, power cords or fuses can be done by the user. Only replace with these items with the exact replacement part[s] available from Leisegang.
19. Position the Colposcope to maintain access to the power outlet it is plugged into to assure ease of disconnection from the power source if needed. To remove all power from the Colposcope, disconnect the power cord from the wall outlet.

Objective Determination

Colposcopes are utilized for the magnified, illuminated gynecological examination of the female genital organs (vulva, vagina and cervix).

With certain model colposcopes, you can attach cameras or digital image management systems for subsequent evaluation and documentation.

Colposcopes are used exclusively for diagnostic purposes and thus correspond to §3, Para. 1 of the MPG, in accordance with the requirements on a medical product.

Be sure you read the Instruction Manual in its entirety to gain a basic understanding of how the colposcope functions before attempting to operate your colposcope.

Should you have any questions, contact CooperSurgical Monday through Friday, 8:30 AM to 5:00 PM E.S.T. CooperSurgical, Inc.

95 Corporate Drive
Trumbull, CT 06611 USA
Phone: (800) 243-2974
Fax: (203) 262-0105

International

Phone: +1 (203) 601-9818
Fax: +1 (203) 601-4747
e-mail: info@coopersurgical.com
Internet: <http://www.coopersurgical.com>

3 Certifications

3.1 CE Certification

The device is tested according to the specifications of the European Medical Device Regulation [MDR EU] 2017/ 745, dated 5th May, and fulfills the necessary standards concerning the MPDG (Medizinproduktegesetz - Durchführungsgesetz / Medical Devices Law Implementation Act). All devices, which are manufactured by Leisegang Feinmechanik-Optik GmbH, belong to Class 1 of non-invasive products, according to Appendix IX of EU Guideline 93/42/EEC.

The colposcopes are checked for compliance with the basic requirements according to Appendix I of Guideline 93/42 EEC and are provided with the CE mark which indicates agreement with the legal stipulations.

A declaration of conformity from Leisegang Feinmechanik-Optik GmbH, as well as full test documentation and protocols, are available on request.

3.2 UL Certification



LEISEGANG COLPOSCOPES
MEDICAL EQUIPMENT WITH RESPECT TO ELECTRICAL SHOCK, FIRE AND MECHANICAL
HAZARD ONLY IN ACCORDANCE WITH THE STANDARDS LISTED BELOW.

The following Leisegang products meet the requirements of the IEC 6060-1 3rd edition: AAMI/ANSI ES 60601-1, IEC 60601-1-2: 2007; IEC 60601-2-41:2009; and CAN/CSA C22.2 NO. 60601.1:08:
Models: 1DL-LED [OPTIK1-XX in USA], 3MVCL -LED [OPTIK2-1X & OPTIK2-1X-XXX in USA], 3MTL-LED [OPTIK2-0X & OPTIK2-0X-XXX in USA], 1E-LED, 1D- LED, 1DS-LED, 1DW-LED, 3ML-LED, 3MLS-LED 1", 3MLS-LED 1/2", 3MLW-LED, 3MVC-LED USB, 3MVCW-LED USB, 3MVCS-LED USB.

Short Product Overview

4 Short Product Overview

Specific terms and technical solutions related to Leisegang colposcopes are explained below. For older Leisegang colposcopes, you may need to reference other manuals.

- Optimal treatment success depends directly on optimum examination results. It is vital that the colposcope supplies a three dimensional image, which represents, as best as possible, the topography and blood vessels of the examination subject. All Leisegang colposcopes, from OptiK Model 1 Series to OptiK Model 2 Series, have the same Leisegang quality optics and all **offer true 3D stereoscopic viewing**.
- Each of the two oculars, or eyepieces, can be adjusted to meet individual eye needs from +7 to -7, so that the operator can work with or without viewing aids. Eyecups can be removed if the user chooses to wear glasses.
- Convergent viewing beam paths correspond to the natural viewpoint; and, in contrast to parallel mode, focus precisely on one predefined point (see diagram). The individual images of both eyes are placed over each other and automatically supply a spatial image, while instruments, which work in microscopic mode, always presuppose a short adaptation phase for the eyes, in order to provide convergence of the parallel individual images for a spatial viewpoint. With an average processing number of 20-40 colposcopic examinations per day, the convergent optical beam is ergonomic by avoiding excess eye strain.

Optical Beam Path

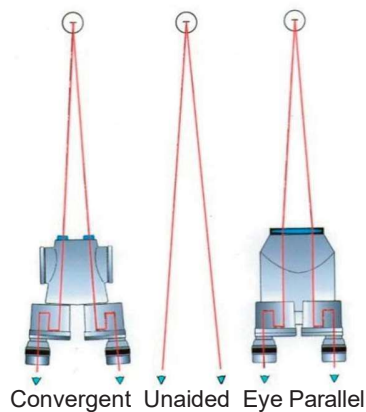

- Reticule Rings are installed in the left ocular pathway to allow you to quickly assess lesion size under direct visualization. A measurement reference chart is located on the left ocular. The chart contains mm measurement for rings A and B at each magnification setting.
- In this document, the term colposcope head refers only to the actual colposcope examination instrument head while the term colposcope describes the entire device with all accessories, from the mount to the power and light source, up to the mains cable.

- A par focal lens is an objective that stays approximately in focus when the magnification is changed. For example, if a colposcope is switched from a low power (3.75x) to a high power (7.5x), the object stays in focus. A par focal lens is not present in all colposcopes, although higher quality colposcopes like Leisegang have this feature. The diagram below shows the par focal distance that is necessary in order to achieve proper viewing distance. The numbers above the dots indicate the area of forgiveness where you can look through the colposcope and view the cervix right before it gets distorted or out of focus.

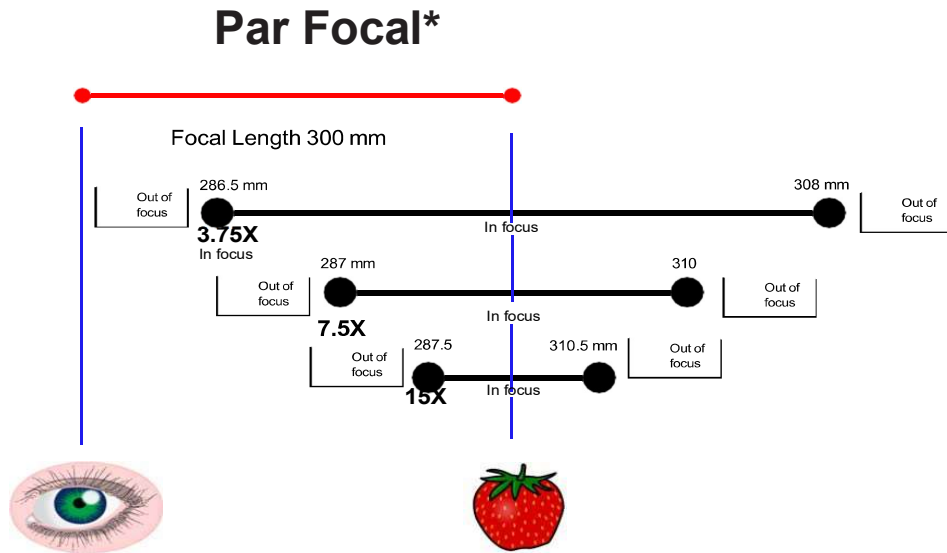

- Leisegang colposcope heads are further distinguished according to model series and type. Every device head bears a punched five-digit serial number, as well as type identification. The identification begins with a digit and up to four more alphabetic characters in accordance to the colposcope type. Every alphabetic character has its own meaning, which provides information about the features of the colposcope head. Differentiation is as follows:
 - **D** = Rotary drum change-over for observation magnification
 - **M** = 3.75/7.5/15x magnification, also for photography
 - **V** = Video colposcope with integrated camera
 - **L** = Photo colposcope, without electronic flash
- The colposcopes of the 1DL, 3ML, 3MLS, 3MTL, OptiK Model 1 series (1DL-LED) and OptiK Model 2 series (3MTL-LED, 3MVCL-LED-USB) are equipped with a rotary changeover for three magnification stages. The scales with the magnification change are 1:2 in each case and result in natural progression of an unmistakable image. In detail, the following magnifications are available: 3.75/7.5/15x.

5 Guarantee

CHANGES IN SPECIFICATIONS FOR PRODUCT. All specifications for the Product are subject to change without notice.

COOPERSURGICAL INC., TRUMBULL, CT 06611 USA.

Contents of this Instruction for Use and other written materials provided to Licensee with the Product may not be reproduced by any means whatsoever without prior written permission from CooperSurgical, Inc. All products mentioned in this Instructions for Use and related written materials are trademarked or copyrighted their manufacturers.

All CooperSurgical, Inc., Products are covered by U.S. and other patents and/or patents pending. All product names are trademarks of CooperSurgical, Inc. All trademarks and the rights of the trademarks owned by the companies referred to in this Instructions for Use and other written materials provided to Licensee with the Product are acknowledged.

WARRANTY FOR PRODUCT

The Product manufactured by CooperSurgical, Inc., is warranted against defects in material and workmanship for twelve (12) months from date of installation. During the warranty period, CooperSurgical, Inc., will repair or replace (at its option) a Product proven to be defective. Warranty repairs may be performed on site, at the factory, or at a CooperSurgical, Inc., approved service center without charge, provided the Product was not subjected to misuse, theft, neglect, fire, Acts of God, lightning strikes, or deterioration caused by chemicals that are not used for normal unit operation.

Any modifications of the Product in any manner, including but not limited to relocation or installation of the Product without prior CooperSurgical, Inc., Customer Service authorization, shall void all associated warranties or service contracts. Prior to prepaid return of products for repair, the Product must have a Return Authorization Number (obtainable from CooperSurgical, Inc., Customer Service) attached to it.

BEYOND THE WARRANTIES STATED ABOVE, THERE ARE NO OTHER WARRANTIES OF ANY KIND, EXPRESS, IMPLIED OR STATUTORY (INCLUDING, WITHOUT LIMITATION, TIMELINESS, TRUTHFULNESS, SEQUENCE, COMPLETENESS, ACCURACY, FREEDOM FROM INTERRUPTION), ANY IMPLIED WARRANTIES ARISING FROM TRADE USAGE, COURSE OF DEALING, OR COURSE OF PERFORMANCE, OR THE IMPLIED WARRANTIES OF MERCHANTABILITY OR FITNESS FOR A PARTICULAR USE OR PURPOSE. LICENSEE'S EXCLUSIVE REMEDY FOR BREACH OF WARRANTY OR BREACH OF CONTRACT, NEGLIGENCE OR PRODUCTS LIABILITY SHALL BE THE REPAIR OR REPLACEMENT OF DEFECTIVE OR DAMAGED GOODS.

6 Colposcopes

6.1 Equipment Overview, Installation and Operation

Before actual use and installation of your device, check the outside of the transport packaging, the devices or subassemblies supplied for damage.

The following chapters give step by step instructions for the testing, installation, operation and security references.

If at this point you notice an obvious defect, please immediately contact CooperSurgical:

CooperSurgical
Attn: Service and Repair
95 Corporate Drive
Trumbull, CT 06611
800-444-8456

6.2 Scope of Delivery and Testing of the Supplied Goods

The scope of delivery of a complete Leisegang colposcope always includes at least the following four items:

- The colposcope head
- The base with special part set (special installation equipment and instructions etc.)
- The power and light source, i.e. transformer
- The accessories, i.e. cables, spare lamps, tools, fitting instructions etc.

Possibly associated with the scope of delivery:

- Additional accessories, such as photographic and video cameras, adapters and external devices such as monitors, laptop computer etc.

These 5 items correspond to the Installation and Operating Instructions. In the case of item 5, please refer to the additionally provided instructions. Please note that during the assembly of the device or devices, the base is always assembled first, then the power and light source and finally the colposcope head with accessories.

Colposcopes

6.3 Standard Colposcopes

OptiK™ Model 1 (1DL-LED)

OptiK Model 1 series includes Leisegang popular standard colposcopes with precision fine adjustments in horizontal and vertical direction, green filter, high performance optics and LED lighting:



OptiK™ Model 1

Features

- 3-step magnification drum changer (3.75x/7.5x/15x)
- Inbuilt LED lamp
- Individually adjusting oculars with reticules
- Reticules in optical pathway for lesion assessment
- Gross and fine focusing and height adjustments
- Green filter
- Ability to upgrade to digital colposcopy systems or analog camera (with additional purchase)

6.4 OptiK™ Model 2 (3MTL-LED, 3MVCL-LED-USB)

The Colposcopes of OptiK Model 2 series are Leisegang's popular Digital/Photo colposcopes with precision fine adjustments in horizontal and vertical direction, high performance optics and LED lighting. The plate identifications for OptiK Model 2 vary according to the camera configuration purchased.



OptiK™ Model 2

Features

- 3-step magnification drum changer (3.75x/7.5x/15x)
- Inbuilt LED Lamp
- Individually adjusting oculars with reticules
- Reticules in optical pathway for lesion assessment
- Gross and fine focusing and height adjustments
- Available in either 1.0" or 0.5" optimized charge coupled device (CCD) with external camera-ready port with matching magnification (3MTL-LED). Or, available with integrated camera (3MVCL-LED USB)
- Green filter

Colposcopes

6.4.1 Camera Adapter

You can connect a digital SLR camera to the port of OptiK Model 2 (3MTL-LED 1.0" only). You will need a special tubus/bayonet depending on the camera. The kind of tubus can be a T2 adapter, video adapter or C-mount camera adapter in several sizes. The tubus/bayonet screws onto the front of the camera. If you received the wrong adapter, please contact us.

The OptiK Model 2 (3MTL-LED) series photo colposcopes have a port for the camera. The internal optics are optimized for 1.0" CCD. If you have purchased 1.0" CCD optimized you must use a 1" CCD or CMOS camera. The camera is attached below the colposcope head. Refer to your specific camera's instructions for use for more information.



You have to use cameras without objective lens.

Connect Camera

1. Place the photo tube onto the camera bayonet. The two red marking points on top must be aligned.
Turn the tube to the right until it is locked firmly.
2. Remove the cover from the camera port of the colposcope head.
3. Push the camera with the tube into the camera port up to the stop.
4. Hold the camera horizontally and tighten the black star grip screw.

6.5 General Adjustments

Most adjustments are the same for all Leisegang colposcopes. Normal adjustments mean the daily use adjustments such as adjusting height, focusing, choosing the magnification, or turning on the green filter.

6.5.1 Rough Height Adjustment



Every colposcope head is packed into a solid plastic bag on delivery, to protect against dust and dirt. The head always represents the last assembled part. It should remain in the bag until final assembly. After assembled, use the supplied dust cover to protect the colposcope while it is not in use.

1. Take the colposcope head from the bag and guide the chrome-plated insertion tube into the previously assembled base.
2. Fix it at the standard height appropriate for the colposcopy, and lightly hand tighten with the aid of the black clamping knob.
3. Ensure that the insertion tube is inserted **at least 20 cm** deep into the mount for a solid fit.

With this knob you can adjust the height of the colposcope in a rough position convenient to your posture:



The fine adjustment is achieved with the fine adjustment handle (see item 1 in section 6.5.2 Vertical and Horizontal Fine Adjustment).

6.5.2 Vertical and Horizontal Fine Adjustment

The most used adjustments are the horizontal and vertical adjustments of the colposcope head. Use the vertical adjustment for your posture/height and the horizontal adjustment for focusing the object.



- | | |
|----------------------------------|--|
| 1 Vertical drive | Moves the colposcope head up and down (max. 80 mm). |
| 2 Horizontal drive- Focus | Moves the colposcope head back and forth (max. 40 mm). |
| 3 Horizontal drive- Tilt | The colposcope head can be tilted by raising or lowering the horizontal drive. |

6.5.3 Compensation of Ametropia

Every Leisegang colposcope has individual adjusting oculars to compensate for both eyes in a diopter range of +7 to -7.

6.5.4 Drum Magnification Dial

You can choose the right magnification / view area for your observation by turning the magnification dial.

Field of view (OptiK Model 1 and OptiK Model 2)

Magnification	Field of view in mm
3.75x	76
7.5x	38
15x	19

6.5.5 Focusing the Leisegang Colposcope



The working distance of a properly focused Leisegang colposcope is about 300 mm or 11.8 inches. A sheet of paper, at 11 inches, is a good starting reference for length between the colposcope and the object of focus.

1. Move the scope head to the center of the traveler using the fine focus adjustment handle.
2. Set both oculars to zero (20/20 vision) and set the step magnification dial to 15x. (The clinician begins an exam at the lowest magnification; however, once you focus at 15x, you will be in focus at 7.5x and 3.75x).
3. Adjust the interpupillary distance (eye separation) to your face, until a single image is visible. This is done by adjusting the binoculars wider or narrower.
4. Looking through the left eyepiece at the targeting reticules only, rotate the left ocular eyepiece until the two double circles are clearly focused. When this is achieved, do not touch this eyepiece for the remainder of the exam.
5. To adjust gross focus, move the colposcope back and forth until you can see the test object clearly with your left eye in the left eyepiece.
6. Rotate the right ocular until you can see the object clearly with your right eye.
7. At this point the colposcope is par focalized. During this exam and all that follow for a particular user there would be no need to touch the two eyepieces.
8. View using both eyes. If needed, move the colposcope back and forth in relation to the subject and adjust the fine focus. With the colposcope par focalized you will have about 300 mm (11.8 inches) of working distance.

6.5.6 Green Filter

With the knob on the right side of the scope you can turn the Green filter in and out.



Colposcopes

6.6 Do-It-Yourself Troubleshooting

All Leisegang Colposcopes and accessories are adjusted prior to shipping. Over the years, daily usage may require you to make special adjustments to the colposcope, such as rough height hold adjustment, etc. This chapter provides an introduction to Do-It-Yourself Troubleshooting.

6.6.1 Fine Height Adjustment

Over the years, your scope head's fine adjustment may need to be tightened in order to hold position. To fix this, you can perform the following steps.

1. Bring the scope in a higher position:



2. Shift the metal cover with type label up:

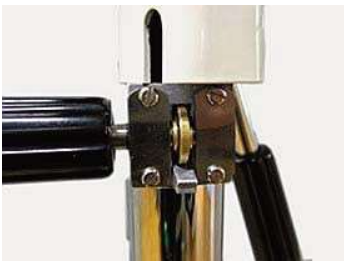

3. Tighten the screws a little bit until it is fixed enough:

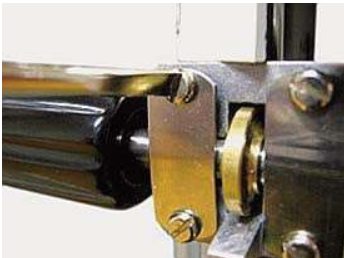

4. Shift the cover down to the original position.

6.6.2 Hold Adjustment for Fine Focus

If the colposcope will not hold the fine focus adjustment position, slightly tighten the knob below the magnification dial:



6.6.3 Fuses

Fuse holder is located at the power supply socket of illumination unit. The fuse is located in a fuse holder. After switching off the device and unplugging the power supply from the device, the fuse holder can be pulled out from the casing with a screwdriver. The fuse can be withdrawn and replaced. For this purpose, it is removed from the fastener and inserted again. Then the mains cable is plugged in again. The fuse cannot be replaced without unplugging the power supply. It is to be ensured that new fuses indicate the same values as the defective ones (see section 13.8. Fuses).

1. With the help of a screwdriver, remove the fuse holder (1) from the mains plug (2):



2. Replace the microfuse (3):

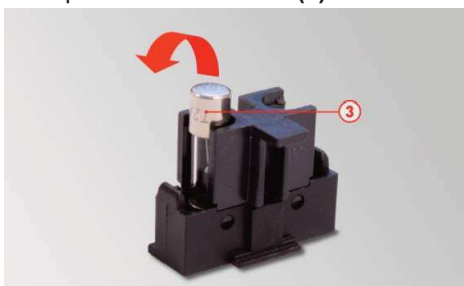

3. Place the fuse holder back into the mains plug.
► The microfuse is now replaced.

Stands

7 Stands

All Leisegang stands (base or mount) are characterized by the highest levels of quality and stability for daily use in practices and clinics. The decision on the type of stand should be made prior to ordering, since the respective stands differ.

NOTE: Stands and spider bases are accessories for the colposcopes and are available at CooperSurgical:

- Swing Stand
- Balance-o-Matic Stand
- Tilt Stand
- Upright Stand (Roller base)

The stand assembly is the first thing built with every new colposcope order.

Please follow the individual stages of the fitting instructions for the respective stand form in the numerical sequence indicated, in order to avoid damage to the device or individual subassemblies.

7.1 Swing Stand

The Swing Stand is the most popular stand worldwide. It consists of two right-angled tubular frames, which enable a horizontal radius of 600 mm with almost 360° pivoting capability.

In addition, the Swing Stand base is a 5-wheel mobile rolling base with two locking casters, which offers free but stable mobility.

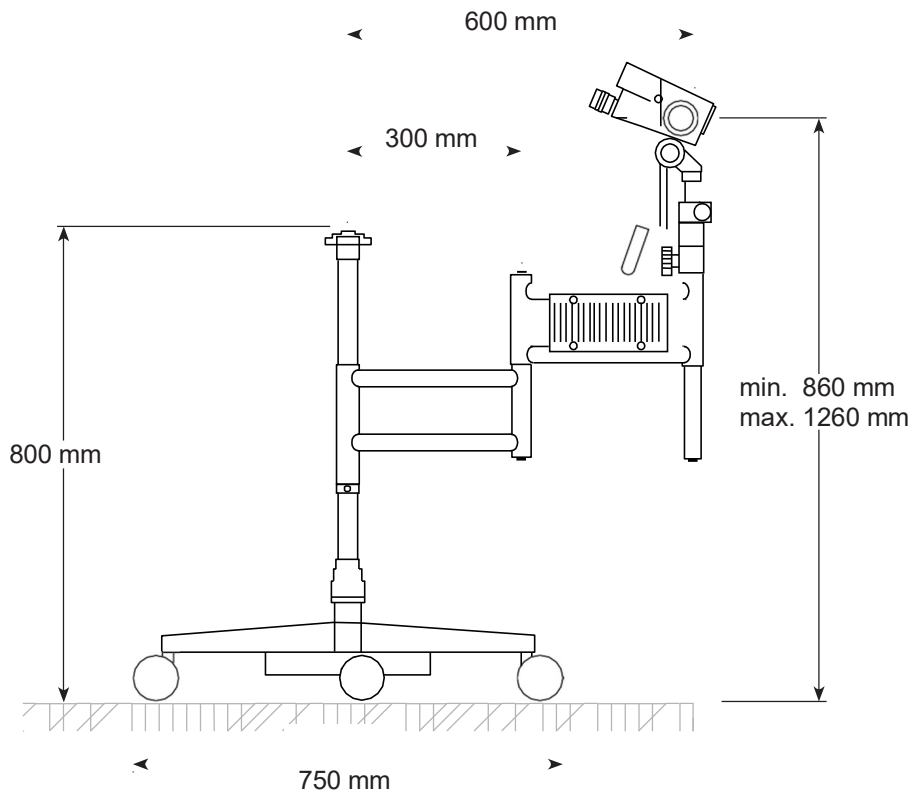

Swing Stand with heavy spider base

Dimensions**7.1.1 Swing Stand Assembly**

See section 7.2.1 *Balance-o-Matic Stand Assembly*. The assembly for both stands is nearly the same. The next step is assembling the illumination unit (see chapter 8 *Illumination Units*).

7.2 The Balance-o-Matic Stand

The Leisegang Balance-o-Matic Stand offers a maximum of comfort with the greatest ease of operability. A two-stage brake arm (1) at the lower stand frame enables the fixed setting of the stand, as soon as the operator has carried out the rough adjustments in the horizontal and vertical direction.



Dimensions

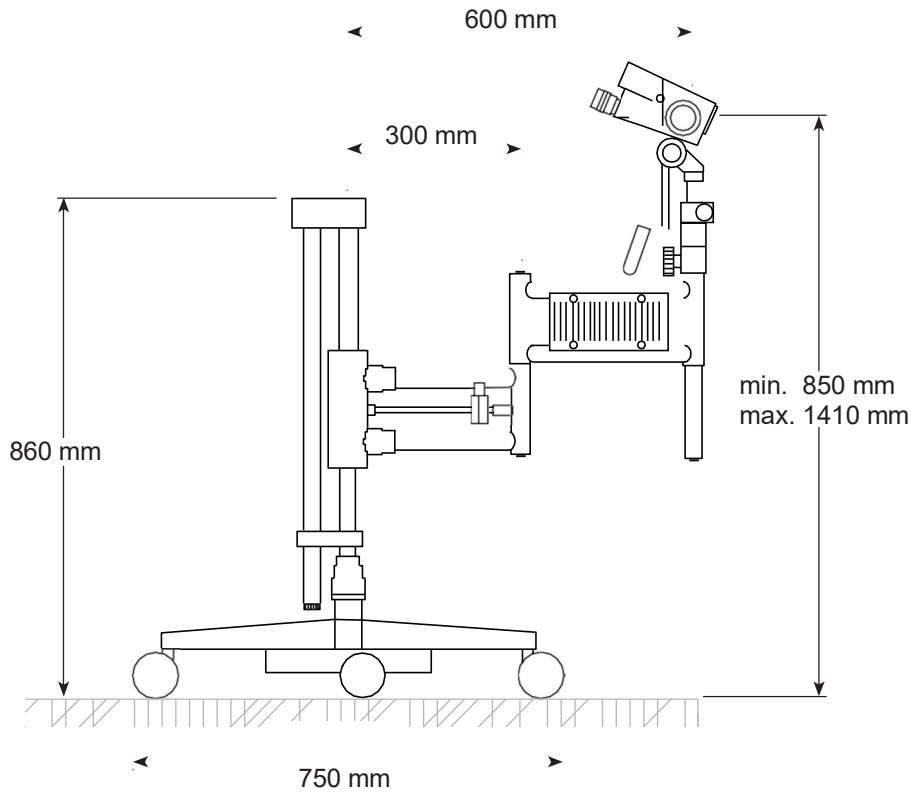

7.2.1 Balance-o-Matic Stand Assembly

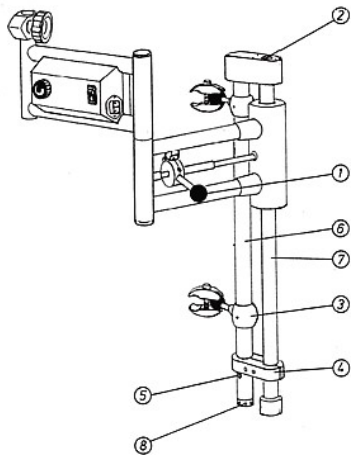

1. Loosen the cross connection (4) and remove with the supplied Allen key.
2. The clamp (3) is displaced upwards with the slit casing over the protection pin (5) and the cross connection is secured again. Ensure the protection pin (5) remains accessible for changing the spring loading.

3. For the purposes of weight compensation, an extension spring is located in the external stand tube, whose loading must be adapted to the weight of the colposcope head, as well as to additional subassemblies, by means of a control ring (8).



CAUTION Risk of crushing through weight

When adjusting the tension of the spring, be careful that the Allen key does not slip away; otherwise, the stand frame may fall down or jump up.

- ▶ To avoid injury, fasten the stand frame before you remove the locking pin.

4. For the adaptation, an Allen key or screwdriver is inserted into one of the holes of the ring; this is then rotated a little to the right against the spring force and the protection pin (5) is pulled out.
5. For safety reasons, a second Allen key or screwdriver should be at hand, since the slow loading or unloading of the spring requires a reinsertion of the lever into the control ring.
6. The ring (8) is now rotated against or with the spring loading until the above-mentioned balanced suspension status of the colposcope is achieved.
7. The ring is arrested again by the reinsertion of the protection pin. Here, the ring is rotated a little back and forth until a hole for the protection pin is found.
 - ▶ With this, the Balance-o-Matic Stand would be firmly connected.

As a next step the illumination unit shall be assembled (see chapter 8 Illumination Units).

7.3 Tilt Stand and Upright Stand (Roller Base)

The Tilt stand is a stable stand for colposcopy and is easily transportable. Rough focus adjustment is achieved by changing the tilt angle.

For transportation of 1DL, OptiK Model 1 Colposcopes (1DL-LED) and OptiK Model 2 Colposcopes (3MTL-LED, 3MVCL-LED-USB), place the colposcope head in the lowest position to assure stability during transportation.

For stability of the 1DL, OptiK Model 1 Colposcopes (1DL-LED) and OptiK Model 2 Colposcopes (3MTL-LED, 3MVCL-LED-USB) in normal use, do not extend the colposcope head greater than 44 inches from the base.



Tilt Stand



Upright Stand

Stands

Tilt Stand

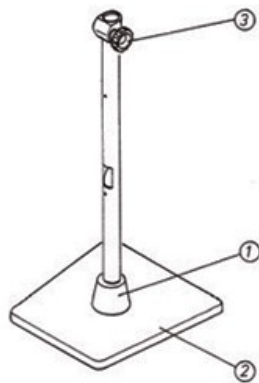

The ball joint **(1)** is screwed securely to the base plate, using the 4 hexagon socket screws. A suitable Allen key is included in the scope of delivery.



The red bolt at the bottom of the base plate **(2)** adjusts the clamping force of the ball joint and determines the force that is necessary to tilt the stand.

The narrow side of the base plate and the transformer are supposed to face toward to the examiner.

The clamping button **(3)** serves, as in the case of other stands, to determine the height of the colposcope.

Upright Stand

In the case of the Upright Stand with light 5-wheel roller base, the same upright stand is used as with the Tilt stand; however, the difference is that the base plate has been replaced by a light rolling base.



Unlike the Tilt, this Upright Stand is not equipped with a tilting link, so that the rough adjustment must be implemented through the movement of the entire system. The fine adjustment is first carried out again, using the focusing drives at the colposcope head.

The stand tube must be inserted with the lower ends (cf. drawing on the opposite page) into the rolling base and tightened up with a locking bolt. There are no further settings possibilities for this stand, except that 2 of the 5 rollers can be set with a brake.

7.4 Installations

7.4.1 Installation of Swing Stand on Mobile 5-Wheel Roller Base



CAUTION Risk of crushing through weight

The counter-weight is heavy and can cause crushing injury.

► The Swing-o-matic stand must be installed by two persons.

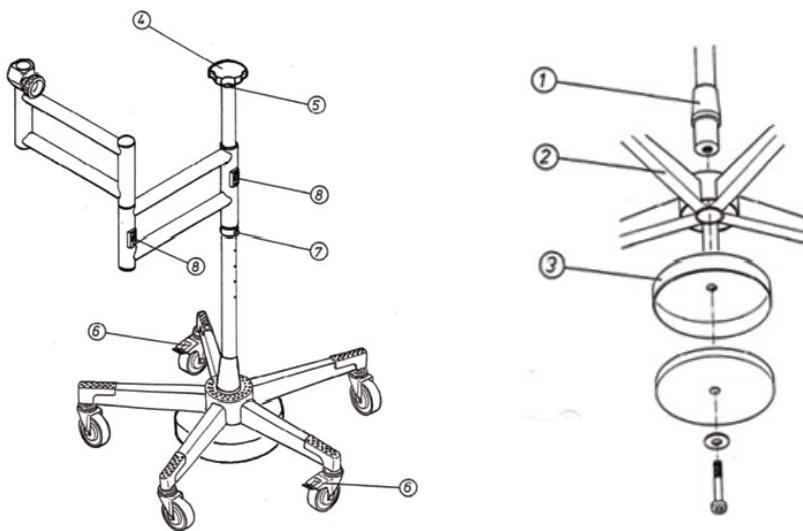

1. The stand upright (1), equipped with a black cone, is inserted into the corresponding receptacle of the 5-wheel roller base (2). The locking weight is securely screwed from below onto the column, using the supplied hexagon socket screw and the spacing washer; the cap (3) is placed securely over the locking weight in order to visually conceal this.
2. The star-shaped handle (4) is used for the guiding of the stand while rolling. After intermediate insertion of the fan washer, it is screwed into the column (5) and tightened up well. Two of the five rollers have a locking facility (6) against unintentional movements of the system.

Stands

3. The stand has been preset in the factory to a predetermined height. In order to change this, slightly pull out the small locking pin (7) at the supporting ring of the lower stand frame and adjust as needed to one of the existing boreholes. Please ensure that the pin audibly engage, in order to prevent slipping of the stand and possible injuries.
4. The Swing Stand is now firmly assembled. For fine adjustment of the horizontal pivot movement you can tighten or loosen pressure screws (8) with a coin at two points.

7.4.2 The Balance-o-Matic Stand on Mobile 5-Wheel Roller Base



CAUTION Risk of crushing through weight

The counter-weight is heavy and can cause crushing injury.

- The balance-o-matic stand must be installed by two persons.

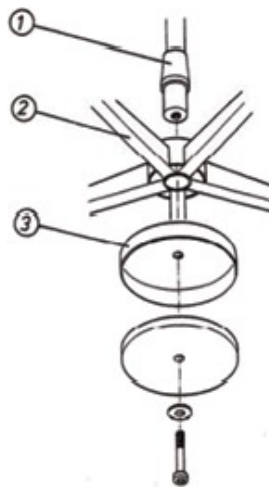
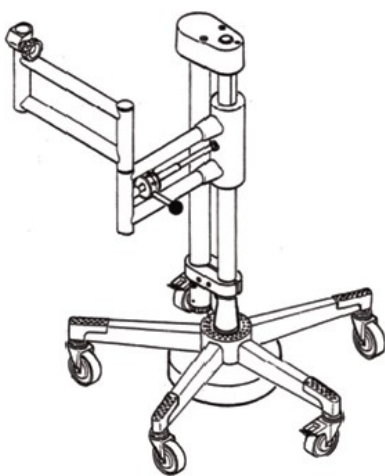

1. The stand upright (1), equipped with a black cone, is plugged into the corresponding receptacle of the 5-wheel roller base (2).
 2. The locking weight is securely screwed from below onto the column, using the supplied hexagon socket screw and the spacing washer.
 3. The cap (3) is placed securely over the locking weight in order to visually conceal this. Two of the five rollers have a locking facility (6) against unintentional movements of the system.
- As a next step the illumination unit shall be assembled (see chapter 8 Illumination Units).

8 Power Supply

Power Supply for LED-illumination.



Note that the box provides an insulated ground versus a wired ground.

The Power Supply can be mounted on the Swing or Balance-o-Matic Stand between the two tubes of the upper frame.

For Upright Stands you have to use two clamps:



WARNING

Injury due to electrical shock

Opening the power supply can result in contact with current-carrying components. Before opening the power supply make sure that the power plug is disconnected.



At the end of power supply unit you will find the two plugs for primary and secondary voltage. The primary voltage plugs holds two fuses. Plug in the lamp cable from colposcope head and turn clockwise until locked.

The illumination unit is approved according to the relevant DIN IEC Standard and carries the serial number on the label.



The illumination unit may be operated only with alternating current with the frequency and voltage indicated on the label. It is not approved for operation in areas with explosion danger.

Illumination Units

8.1 LED-Lighting



LED Unit

LED stands for Light Emitting Diode, this light is produced in an electronic process in semiconductor without substantial heat losses.

LED Colposcopes are equipped with an LED unit. This consists of a heat sink unit with LED and the condenser lens optics. In addition it provides another light character for a more plastic impression, than the lamps used in the past.

The used power supply unit weights 500 g or 1.1 lb and possesses a power consumption of maximum 3.2 V, 3 A (Output).

With a life span of more than 20,000 operation hours this lighting can work a whole working life (estimated at 4 hours per day). Should you experience an LED light failure, please check the power supply unit first.



In the unlikely event that a replacement of the LED light is necessary it should be done by an authorized electrical specialist. Otherwise contact CooperSurgical

9 Accessories

CooperSurgical offers several kinds of accessories:

- Video Adapter
- Cameras
- Image Management Software
- Bases

The following sections provide more information on the above bold items.

9.1 Video Adapters

All Leisegang colposcopes accept the Leisegang video adapter via a mounting plate which can be mounted with 3 screws at the front of the scope. The video adapter can easily be mounted using the supplied tools.

Leisegang video adapters are available in the US with three-step magnification of 3.75x, 7.5x, 15x. Please refer to the camera's specific Instructions for Use for more information.

9.1.1 Mounting Video Adapters

1. Fasten the mounting base plate with three screws:



2. Align the mounting plate and video adapter, fasten area one above the other:



Accessories

3. Push both pins of video adapter and fasten area into mounting base plate and tighten the screw knob clockwise:



- Video adapter is ready to use.

9.2 Cameras

CooperSurgical offers the following camera:
Canon EOS Rebel dSLR



The Canon EOS Digital Rebel (dSLR) is designed for use with the OptiK Model 2 with 1.0" CCD (3MTL LED 1.0"), using a special bayonet. A potential disadvantage of these cameras is that they are unable to create a live video picture. However, the image quality from these cameras is excellent for academia, gynecologic oncology studies, Sexual Assault/Physical Abuse cases, or other clinical trials. Images are saved to a memory card for manual export.

Please refer to the appropriate Instructions for Use (IFU) for more information if you have purchased these items.

10 Care and Maintenance

Colposcope care and maintenance is simple - no great effort is needed to keep your device in a tidy and functional condition. It is recommended that the colposcope be handled with gloves. We also recommend that you consistently carry out the measures described below, in order to ensure long term and trouble free functioning.

10.1 Disinfection

**WARNING Injury due to electric shock**

The power supply unit is not protected against the ingress of water. Penetrating fluid can result in electric shock.

- ▶ Always unplug the device before cleaning.

Colposcope, stand

**CAUTION Damage to the device**

To avoid damage to the device, observe the following instructions for cleaning and disinfection:

Cleaning

- ▶ Wipe the colposcope and the stand with a damp (not wet!) cloth regularly. Standard detergents should be used at suitable dilution. Afterwards, wipe with a dry, non-fuzzing cloth.
- ▶ Do not use harsh or corrosive cleaning agents! They can cause damage to the surface.
- ▶ Avoid splashing water, as this could damage the device.

Disinfection

- ▶ Disinfect the device using disinfectants according to your internal hygiene plan.
- ▶ The solutions applied for the manual cleaning and disinfection need to be used according to the manufacturer's instructions and their specified exposure time must be observed.
- ▶ When choosing a disinfectant, please follow the recommendations of your national hygiene standards.

Care and Maintenance

Lenses



CAUTION **Damage to the device**

To avoid damage to the equipment, observe the following cleaning instructions:

- ▶ You can use a watery soap solution for cleaning the lenses. Use special lens cloths to wipe the lens dry.
- ▶ Do not use harsh or corrosive cleaning agents! They can cause damage to the surface.

Power supply unit



WARNING **Injury due to electric shock**

The power supply unit is not protected against the ingress of liquids. Penetrating fluid can result in electric shock.

- ▶ Avoid drips and splashes.
- ▶ Do not spray cleaning or disinfecting solutions on the power supply unit.

Other components (photo/video adapter, photo equipment, cameras)



WARNING **Damage to the device**

To avoid damage to the equipment, observe the following cleaning instructions:

- ▶ Observe the same instructions as listed under Colposcope, stand and Lenses.
- ▶ Do not attempt to clean the lenses within the adapter or camera! This will cause damage to the equipment.

11 Replacement Wear Parts and Technical Service

11.1 Technical Service

When contacting CooperSurgical's Service and Repair department for servicing Leisegang colposcopes, you will need the following information: Details on the defect that has occurred and corresponding serial numbers of the individual components. These can be read off from the punched digits on the metal labels. In the case of the individual subassemblies, the labels are situated at the following locations:

- Colposcope head with standard and photo colposcopes (Series 1-3): At the insertion tube on the cap
- Transformer: On the reverse side of the operating controls.
- Video adapter: On the side.

Communication of the serial number expedites the support from CooperSurgical. For questions concerning service, please contact us at:

CooperSurgical, Inc.
95 Corporate Drive
Trumbull, CT 06611 USA
Phone: (800) 444-8456
Fax: (203) 262-0105

International:

Phone: +1 (203) 601-9818
Fax: +1 (203) 601-4747
Internet: <http://www.coopersurgical.com>

11.2 Spare and Worn Parts

As well as these Instructions for Use, there is a spare parts list in which all relevant spare and wear parts are listed. Repairs and interventions on the devices are to be carried out only by CooperSurgical. Some items may be remedied by the user, such as replacement of worn parts including: lamps, eyepiece rings, light guides and fuses. The procedure is described below.

11.2.1 Lamp Change

See Chapter 6.6 *Do-It-Yourself Troubleshooting*.

11.2.2 Fuses

See Chapter 6.6 *Do-It-Yourself Troubleshooting*.

12 Technical Data and Notes on Safety

12.1 EMC - Electromagnetic Compatibility

Leisegang Colposcopes are tested for compliance to IEC 60601-1-2:2007- Medical Electrical Equipment PART 1-2: General Requirements for Basic Safety and Essential Performance Collateral Standard: Electromagnetic Compatibility. Use only approved and authorized Leisegang replacement components. Compliance with the corresponding specifications is indicated by the CE marking.

12.2 Control and Maintenance



Quality controls are carried out for all Leisegang devices. The following best practices are recommended:

- Ensure that cables, light guides, cable releases and other cables are not too tight or tangled. Unplug tangled connections and plug these back after unraveling.
- Ensure that electric connections and mains cables do not indicate any external damage. Replace defective cables immediately.
- Occasionally check that the locking weight under the roller base has not loosened. If so, tightened screws.
- Ensure that mechanical adjustments are working smoothly and correctly. In case of occurrence of problems, contact Cooper Surgical Service and Repair Department
- Regularly check the steel pulling cable for wear.

12.3 Returns, Complaints

Returns of devices or subassemblies requires prior arrangement with CooperSurgical through a Service and Repair Authorization form. Please contact our Service and Repair department to discuss the issue, repair estimates and to make arrangements. Complaints about devices or subassemblies supplied by us are to be communicated to us immediately, with information of the serial number, the delivery date and the reason for the complaint. Please send your complaint in writing to the following address (Fax or e-mail is sufficient):

CooperSurgical, Inc.
95 Corporate Drive
Trumbull, CT 06611 USA
Phone: (800) 243-2974
Fax: (203) 262-0105

International

Phone: +1 (203) 601-9818
Fax: +1 (203) 601-4747
Internet: <http://www.coopersurgical.com>

13 Technical Data

13.1 Type Plates

Except for stands, all Leisegang devices carry type plates. The contents of type plates show the product name and the serial number. Electrical devices show the power data and additional information such as year of construction and CE and/ or UL mark.



- 1 Type plate power supply
- 2 Type plate colposcope head

13.1.1 Type Plate Colposcope Head

Type plate of colposcope		
Model number	COLPOSCOPE	Device name
Serial number	REF 3MVCL - 131112	CE-mark
Manufacturer	SN 00-000000	Date of manufacture
	2014-00	Input
	Leisegang GmbH	Separate disposal of waste electrical devices
	Leibnizstr. 32, D-10625 Berlin	
	Input 3.2V, 3A	
	Rev. 1.0	

This plate is located below the head. It shows the model number (see chapter 13.15 Model number) and serial number.

The serial number is important if you have any questions or complaints.

13.1.2 Type Plate Power Supply

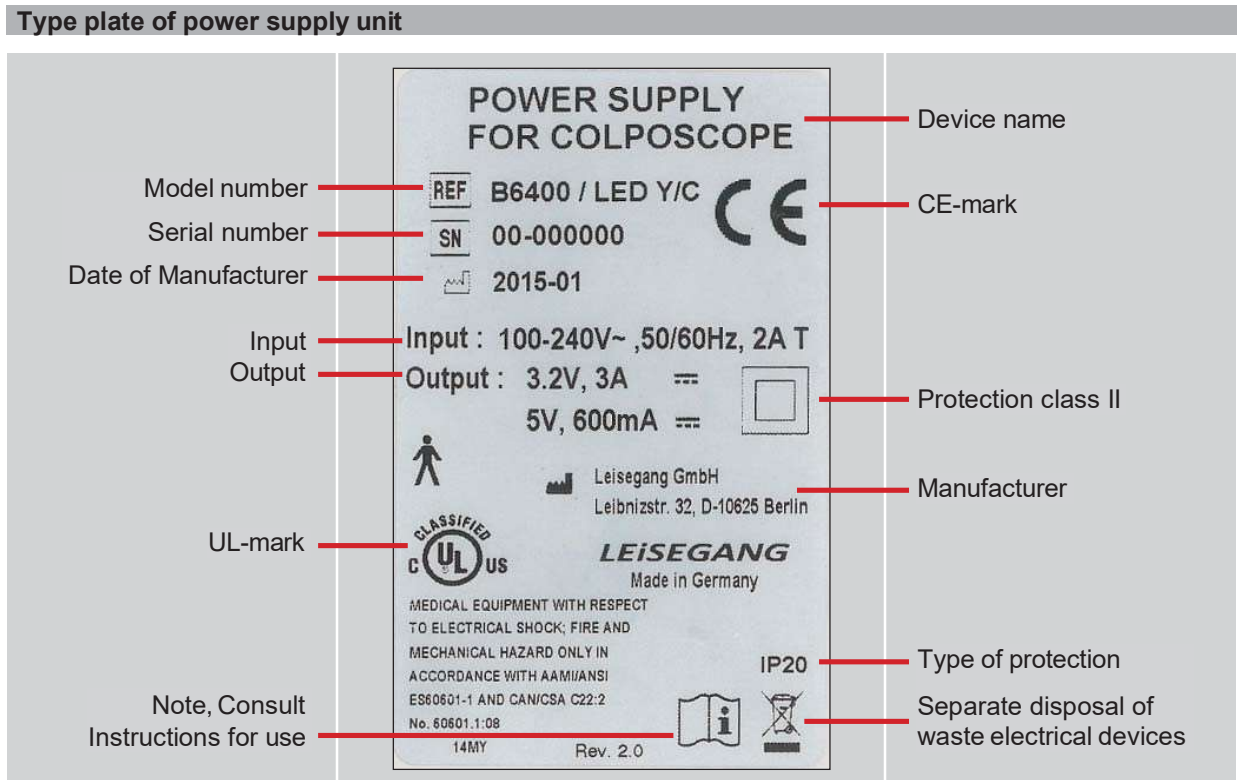

This plate is located on the front side of the powers supply. It holds the model type and serial number, the primary and secondary voltage, the year of construction and CE mark.

The serial number is important if you have any questions or complaints.

13.2 Classification

Classification according to MDR (EU) 2017/745:
 Class II - LED
 Application part

13.3 Safety Class

	Type		Safety Class
LED Unit	B		

Technical data

13.4 General

Operational data

Mode of use	Not suitable for use in an oxygen-enriched environment
Operating mode	Suitable for continuous operation
Applied parts	The device has no applied parts that come into direct contact with the patient
Working distance	300 mm

13.5 Devices with magnification 3.75x/ 7.5x/15x

Power supply unit **REF** B 6400 / LED Y/C

Input	100-240 V ~, 2 Amax, 50/60 Hz
Output	3.2 V === 3 Amax 5 V === 600 mAmax
Protection against electric shock	 Protection class II
Protection against harmful ingress of solids and liquids	IP 20

Integrated illumination

LED	Light-emitting diode
Power consumption	10 W
Intensity of illumination EV	Up to 31.000 lx (with a distance of 300 mm)
Color temperature T F	3000 K
Light field diameter	78 mm
Field of view diameter	76/38/19 mm

Technical Data

13.6 Environment Conditions

Environment and storage conditions	
Environment temperature	10-45 °C
Relative humidity	30-75 %, non-condensing
Air pressure	700-1.060 hPa
Storage	Dry, cool, protected from dripping water, protected from condensation

13.7 Dimensions and Weights

(all Information approx.)

Device	Weight
Standard colposcope head	3.5 kg
Swing Stand	7.0 kg
Balance-o-Matic Stand with weighted base	24.5 kg
Upright stand with roller base	7.0 kg
Tilt stand	3.0 kg
LED Power Supply	0.5 kg
Device	Dimensions
Roller base footprint	65 x 65 cm
Tilt footprint	30 x 30 cm
Bases for mounts (spider base)	65 x 65 cm
Bases for mounts (tilt mount)	30 x 30 cm

13.8 Electrical Connections

LED Colposcopes	
Rated voltage: Please note information on label	100 - 240V~
Nominal frequency: Please note information on label	50/60 Hz
Wattage	45 Watts

13.9 Power Consumption

LED Colposcopes	
Power Supply 18W LED (LED Colposcopes only)	24 VA

13.10 Lamps

LED module with heat sink, LED and Condenser optic	24 VA24V / 10W
--	----------------

13.11 LED Light Specification

Color Rendering Index	92 (Typical)
Lifetime (with Junction Temperature of 90° C)	Min. 10,000 Hours
Total Irradiance (at max Intensity at 1 Meter)	Min. 10,000 Hours

13.12 Leisegang Colposcopes EMC Compliance Information

- MEDICAL ELECTRICAL EQUIPMENT needs special precautions regarding EMC and needs to be installed and put into service according to the EMC information provided in the ACCOMPANYING DOCUMENTS.
- Portable and mobile RF communications equipment can affect MEDICAL ELECTRICAL EQUIPMENT.

13.13 Electromagnetic compatibility

Leisegang colposcopes are intended for use in an environment, that meets the below mentioned electromagnetic specifications.

Leisegang colposcopes have been designed to withstand the effects of EMI (electromagnetic interference) and meet the most current EMC standards. However, extremely high levels of electromagnetic energy (above the levels mentioned in IEC 60601-1-2) may still cause interference.

In order to reduce the risk of EMI, follow these recommendations:

- Do not turn on or use mobile communication devices, such as mobile two-way radios or cellular phones, in the proximity of the instrument. If the use of such equipment is required, please note the details on 'recommended distance' in the following tables.
- In the event of unexplained EMI, check if there are any transmitters, such as radio or TV stations, located nearby. Either the location of the device may need to be changed or shielding between the sender and the unit may need to be installed.
- We would like to point out that a change to the device or the addition of accessories or components could make the device more susceptible to the interference of radio waves.

**Table 1:
Guidance and Manufacturer's Declaration – Electromagnetic Radiation**

Leisegang Colposcopes are intended for use in the electromagnetic environment specified below. The customer or the end user of Leisegang Colposcopes should assure that it is used in such an environment.

Emissions Test	Compliance	Electromagnetic Environment- guidance
RF emissions CISPR 11	Group 1	Leisegang Colposcopes use RF energy only for it internal function. Therefore, its RF emissions are very low and are not likely to cause any interference in nearby electronic equipment.
RF emissions CISPR 11	Class B	Leisegang Colposcopes are suitable for use in all establishments other than domestic and those directly connected to the public low-voltage power supply network that supplies buildings used for domestic purposes.
Harmonic emissions IEC 61000-3-2	Class A	NOTE: The EMISSIONS characteristics of this equipment make it suitable for use in industrial areas and hospitals (CISPR 11 class A). If it is used in a residential environment (for which CISPR 11 class B is normally required) this equipment might not offer adequate protection to radio-frequency communication services.
Voltage fluctuations/ Flicker Emissions IEC 61000-3-3	Complies	The user might need to take mitigation measures, such as relocating or re-orienting the equipment.

**Table 2:
Guidance and Manufacturer’s Declaration – Electromagnetic Immunity**

Leisegang colposcopes are intended for use in the electromagnetic environment specified below. The user of a Leisegang colposcope must ensure that the device is being operated in such an environment.

Immunity Test	IEC 60601 Test Level	Compliance Level	Electromagnetic Environment guidance
Electrostatic discharge (ESD)	±6 kV contact	+6 kV contact	Floors should be wood, concrete or ceramic tile. If floors are covered with synthetic material, the relative humidity should be at least 30%.
IEC 61000-4-2	±8 kV air	+8 kV air	
Fast electrical transient/burst	+2 kV for power supply lines	+2 kV for power supply lines	The main power supply should be equal to that of a typical commercial facility or a hospital. .
IEC 61000-4-4	+1 kV for input/output lines	+1 kV for input/output lines	
Surge	+1 kV differential mode	+1 kV differential mode	The main power supply should be equal to that of a typical commercial facility or a hospital.
IEC 61000-4-5	+2 kV common mode	+2 kV common mode	
Voltage dips, short interruptions and voltage variations on power supply input lines IEC 61000-4-11	<5 % UT (>95 % dip in UT) for 0,5 cycles	<5 % UT (>95 % dip in UT) for 0,5 cycles	The main power supply should be equal to that of a typical commercial facility or a hospital. If the user of a Leisegang colposcope requires continued operation during power mains interruptions, it is recommended that the Leisegang colposcope is powered by an uninterruptible power supply or a battery.
	<40 % UT (60 % dip in UT) for 5 cycles	<40 % UT (60 % dip in UT) for 5 cycles	
	<70 % UT (30 % dip in UT) for 25 cycles	<70 % UT (30 % dip in UT) for 25 cycles	
	<5 % UT (>95 % dip in UT) for 5 seconds	<5 % UT (>95 % dip in UT) for 5 seconds	
Power frequency (50/60 Hz) magnetic field IEC 61000-4-8	3 A/m	3 A/m	The magnetic fields of the power frequency should be within a range that is characteristic for a typical commercial environment or in the environment of a hospital.

NOTE: UT is the a.c. mains voltage prior to application of the test level. In this case 230 V.

Technical Data

Table 3:
Guidance and manufacturer's declaration - electromagnetic immunity

Leisegang colposcopes are intended for use in the electromagnetic environment specified below. The user of a Leisegang colposcope must ensure that the device is being operated in such an environment.

Immunity Test	IEC 60601 Test Level	Compliance Level	Electromagnetic Environmental guidance [Note 1 & 2]
Conducted RF IEC 61000-4-6 Radiated RF IEC 61000-4-3	3 V rms 150 kHz to 80 MHz 3 V/m 80 MHz to 2.5 GHz	3 V rms 3 V/m	<p>Portable and mobile RF communications equipment should be used no closer to any part of the Leisegang Colposcope, including cables, than the recommended separation distance calculated from the equation applicable to the frequency of the transmitter.</p> <p>Recommended separation distance</p> $d = 1.17\sqrt{P} \text{ 80 MHz to 800 MHz}$ $d = 2.33\sqrt{P} \text{ 800 MHz to 2.5 GHz}$ <p>where P is the maximum output power rating of the transmitter in watts (W) according to the transmitter manufacturer and d is the recommended separation distance in meters (m).</p> <p>Field strengths from fixed RF transmitters, as determined by an electromagnetic site survey, should be less than the compliance level in each frequency range b Interference may occur in the vicinity of equipment marked with the following symbol:</p> 
Note 1:	At 80 MHz and 800 MHz, the higher frequency applies.		
Note 2:	These guidelines may not apply in all situations. Electromagnetic propagation is affected by absorption and reflection from structures, objects and people.		
a)	The field strength of fixed transmitters, such as base stations for (mobile/cordless) phones and public land mobile radios, amateur radio, AM and FM radio stations and TV transmissions can, in theory, not be predicted accurately. In order to assess the electromagnetic environment due to fixed RF transmitters, a factory-made electromagnetic site survey is recommended. If the measured field strength in the location, in which the Leisegang colposcope is being operated, exceeds the above-mentioned RF compliance level, particular attention must be paid in order to guarantee a normal operation of the Leisegang colposcope. If an incorrect operation is observed, additional measures may be required, such as the realignment or relocation of the Leisegang colposcope.		
b)	Above the frequency range of 150 kHz to 80 MHz, the field strength should be less than 3 V/m.		

Table 4:
Recommended separation distance between portable/mobile RF communications device and a Leisegang colposcope - valid for equipment and systems not intended for life-sustaining applications

Leisegang colposcopes are for use in an electromagnetic environment in which radiated RF disturbances are monitored. The user of a Leisegang colposcope can help prevent electromagnetic interference by maintaining a minimum distance between the portable/mobile RF communications device (transmitter) and the Leisegang colposcope as recommended below; this minimum distance is determined by the maximum output power of the communications device.

Maximum output power of transmitter W	Separation distance according to frequency of transmitter (Meters) [Note 1 & 2]		
	150 kHz to 80 MHz $d = [3.5 / 3] \sqrt{P}$	80 MHz to 800 MHz $d = [3.5 / 3] \sqrt{P}$	800 MHz to 2.5 GHz $d = [7 / 3] \sqrt{P}$
0.01	0.12	0.12	0.23
0.1	0.37	0.37	0.74
1	1.2	1.2	2.3
10	3.7	3.7	7.4
100	12	12	23

For transmitters rated at a maximum output power not listed above, the recommended separation distance d in meters (m) can be estimated using the equation applicable to the frequency of the transmitter, where P is the maximum output power rating of the transmitter in watts (W) according to the transmitter manufacturer.

Note 1: At 80 MHz and 800 MHz, the higher frequency applies.

Note 2: These guidelines may not apply in all situations. Electromagnetic propagation is affected by absorption and reflection from structures, objects and people.

13.14 Model number

The model number (**REF**) consists of the following categories:

	Ocular view			Magnification			Head calibration		Lighting	Camera interface			Chip size					
Number	1			2			3		4	5			6					
Model name	Straight	45° tilted	1 15x	D 7.5/15/30x	S 3.75/7.5/15x		Fine	Tilting only	LED	--	USB	Y/C	NTSC	--	1/4"	1/3"	1/2"	1"
Code	XXX –	1	2	1	2	3	1	2	1	0	1	3	0	1	2	3	5	

Example:	1D 121100	1			2		1		1		0				0			
-----------------	------------------	----------	--	--	----------	--	----------	--	----------	--	----------	--	--	--	----------	--	--	--

The example below shows the model name for a model 1D LED device with the following features:

Digit 1: straight insight

Digit 2: 7.5- / 15- / 30-fold magnification

Digit 3: Option to fine adjust height, tilt and sharpness

Digit 4: LED-Lighting

Digit 5: Without camera interface

Digit 6: Without chip