



DENTAL

Instrument Processing



Designing Better Care



**WE BELIEVE DESIGN IS ABOUT
NOT JUST THE WORKFLOW, BUT
THE PEOPLE WORKING IN IT.**

Simplify your instrument
processing workflow and get
your team back to the work
they love. Choose technology
designed with them in mind.



Simplify Safety

Don't let one dirty instrument ruin your reputation.

Learning and maintaining proper infection prevention protocols can lead to stress, anxiety and even burnout for dental professionals.

But one dirty instrument could ruin your reputation. Keep everyone safe and reduce stress with easy-to-learn equipment and a standardized workflow.

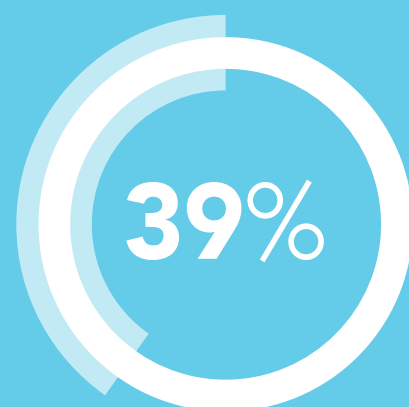

39% of dentists report being more stressed during the workday due to software or equipment.¹



Table of Contents

- 06 Design a Safer Practice through Safer Instrument Processing
- 08 Improve Employee Retention
- 10 Start with Workflow: 5-Step Instrument Processing Workflow
- 12 Configure Your Space
- 14 Maximize Your Design
- 16 Choose the Right Equipment Capacity
- 18 Things to Consider
- 20 Midmark® Products and Solutions
- 22 Lubricare 2® Dental Handpiece Care + Maintenance System by Bien-Air®
- 24 QuickClean® Ultrasonic Cleaners
- 26 Midmark® Steam Sterilizers
- 32 Clinical-Grade Cabinetry for Your Sterilization Center
- 34 Synthesis® Sterilization Center Cabinetry
- 36 Artizan® Expressions Sterilization Center Cabinetry
- 38 Cabinetry Finishes and Style Options
- 42 Compare Quality: Midmark Clinical-Grade Cabinetry vs. Consumer-Grade Cabinetry
- 44 See What Our Customers Are Saying
- 46 Tools for Success



▶ Instrument Processing Products

Design a Safer Practice through Safer Instrument Processing

As one of the most highly trafficked areas of your practice, the sterilization center is an essential hub for efficiency and risk control.

Consider your workflow, processes and equipment as you design your optimal sterilization center.



80–120

Number of times per day **your team may go in and out of the instrument processing area** based on average dental practices²



75%

Percentage of offices in the US that have an **inadequately sized sterilization center**³



30–50%

Percentage of **sharps injuries** occurring during instrument processing procedures⁴

2, 3, 4 See inside back cover for details and sources

Improve Employee Retention

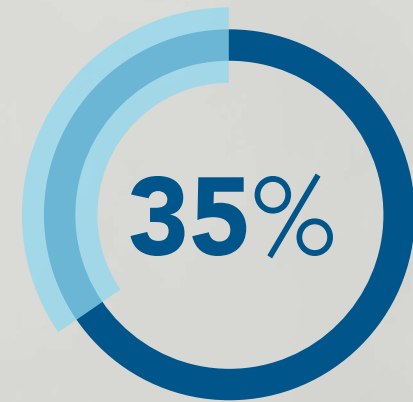

35% of dental respondents found recordkeeping at least moderately frustrating.⁵

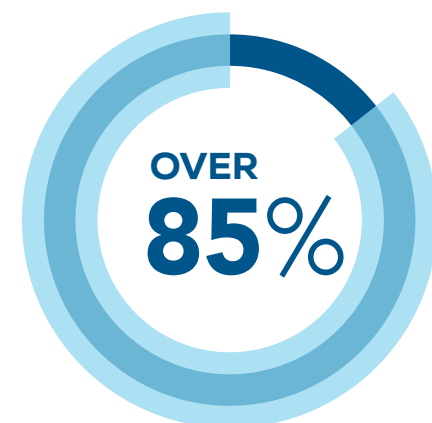

According to the American Dental Association (ADA), over 85% of dental facilities say it is very or **extremely challenging to recruit qualified dental assistants and hygienists.**⁶

STRESS + BURNOUT

Dental assistants and hygienists report feeling stressed and overburdened. Left unchecked, these feelings can lead to burnout, which is a major cause of employee turnover.

Piling training responsibilities on top of an already full workload can further contribute to employee burnout. But training is crucial to improving employee confidence and efficiency and reducing patient risk—especially in the sterilization center, which is the core of safety and compliance.

MAKE "EASY" YOUR STANDARD

Reduce the burden of training with standardized processes and instrument processing solutions designed to be easy to use. Select cabinetry designed to follow a CDC-recommended dirty-to-clean workflow.⁷ Choose the Lubricare[®] 2 system from Bien-Air[®] to deliver just the right doses of cleaner and lubricant to your handpieces. Automate instrument cleaning with the QuickClean[®] Ultrasonic Cleaner. Simplify sterilization using Midmark[®] Steam Sterilizers designed with intuitive on-device sterilizer tutorials, step-by-step prompts, preset and custom cycles, and automatic recordkeeping.

^{5, 6, 7} See inside back cover for details and sources

Start with Workflow

5-STEP INSTRUMENT PROCESSING WORKFLOW



Follow a dirty-to-clean instrument processing workflow as recommended by the CDC⁷ to help contain contamination and maximize the efficiency of your instrument cleaning and sterilizing process.



STEP 1 Receiving + Cleaning

Reusable instruments, supplies and equipment should be received, cleaned and disinfected in one section of the processing environment. Remember to clean handpieces on both the outside and inside.



STEP 2 Preparation + Packaging

Cleaned, dried instruments and other supplies should be inspected for residual debris and damage, assembled into sets or trays, and wrapped or packaged for sterilization.



STEP 3 Sterilization

The sterilization area should include the sterilizer and related supplies with adequate space for loading and unloading the sterilizer. Follow the instructions for use (IFU) on cleaning and sterilizing for each instrument.



STEP 4 Monitoring/Sterility Assurance

Mechanical, chemical and biological monitoring should be used to ensure the efficacy of the sterilization process. Results of sterilization need to be recorded.



STEP 5 Storage

The storage area should be adequately sized, closed or covered, and located apart from contaminated instruments in an area protected from moisture. Supplies and instruments should not be stored under the sink.

Configure Your Space

The following layout options are designed to follow a 5-step, standardized instrument processing workflow for better adherence to clinical best practices within the space you have available.

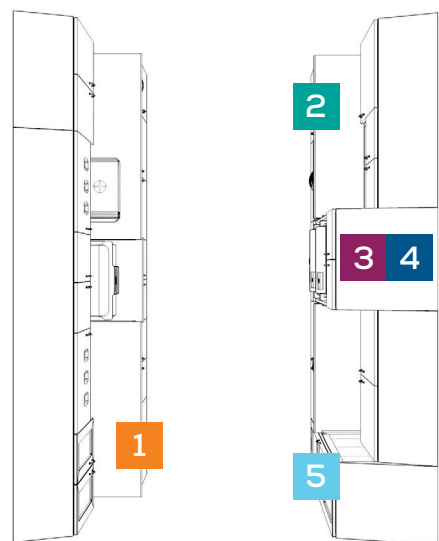

GALLEY

The galley layout consists of workspaces on two opposing walls with a single traffic lane between. This arrangement allows for easy access and efficient workflow, helping your team keep the process moving using a linear flow while keeping everything within reach.

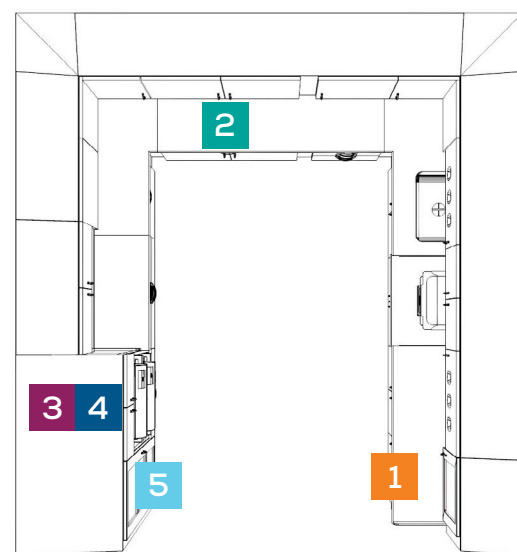

U-SHAPED

Multiple cleaners and sterilizers demand space—a U-shaped workspace design provides that and more. Ample surface areas allow more of your team in the room to multitask and maintain a bustling workflow.

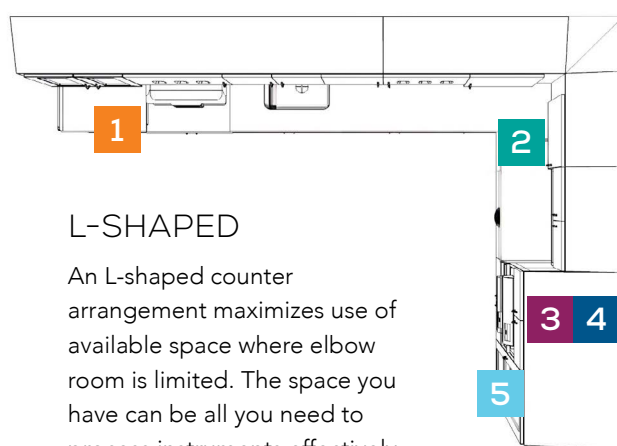

L-SHAPED

An L-shaped counter arrangement maximizes use of available space where elbow room is limited. The space you have can be all you need to process instruments effectively and safely.

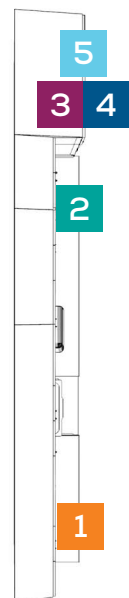

STRAIGHT LINE

Perfectly suited to a 5-step instrument processing workflow, a straight-line workspace design can help maximize efficiency for effective infection prevention.



Maximize Your Design

A well-designed sterilization center is not just an engine of productivity for your practice but also an essential asset in infection prevention. Ample countertop space allows easy separation of dirty and clean instruments during processing. Ample cabinet storage can help keep your instrument processing area clean and organized.



01



03



04



05

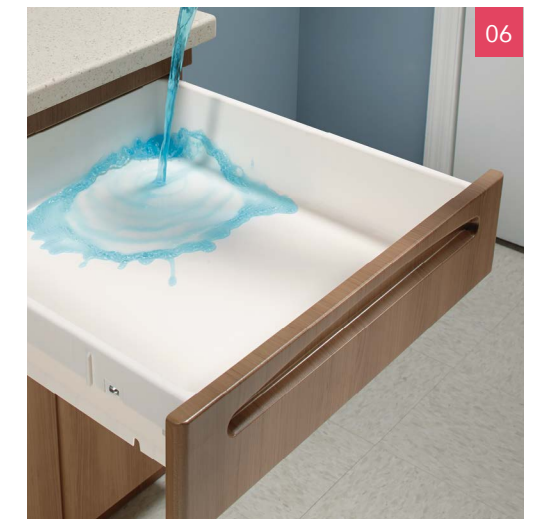

06



02



02

01 Start the critical first step of instrument processing with Lubricare 2[®], a complete handpiece care and maintenance system from Bien-Air[®].

02 Help your team maintain a clean and safe sterilization center with multiple trash-drop options, including hands-free operation.

03 Minimize surface contamination when cleaning or rinsing instruments with a hands-free gooseneck faucet.

04 Maximize visible, usable storage with Midmark flow-shelving options.

05 Simplify access to all sides of your sterilizer with a strong solid-surface slide-out shelf.

06 Support asepsis with seamless thermofoil panels and polystyrene drawers.

Choose the Right Equipment Capacity

When choosing your sterilizers and ultrasonic cleaners, consider the number of doctors and hygienists in your practice to determine the number and sizes of equipment you need. Reference the “Choose the Right Capacity” chart to help you decide.









LET US DESIGN YOUR STERILIZATION CENTER WITH YOU

Midmark design experts are ready to help you create your optimal sterilization center. From proper equipment sizing to cabinetry and layout, we'll work with you to design the best environment for your practice.

CHOOSE THE RIGHT CAPACITY

Number of Clinicians	Recommended Number of Sterilizers	Recommended Models of Sterilizers	Recommended Models of Ultrasonic Cleaners
1-2 Doctors and 2-4 Hygienists	2 Sterilizers	2 M11® Sterilizers -or- 1 M11 Sterilizer and 1 M9® Sterilizer	QuickClean® QC3
3 Doctors and 3-5 Hygienists	3 Sterilizers	3 M11 Sterilizers -or- 2 M11 Sterilizers and 1 M9 Sterilizer	QuickClean® QC6
4 Doctors and 4-6 Hygienists	4 Sterilizers	4 M11 Sterilizers -or- 3 M11 Sterilizers and 1 M9 Sterilizer	QuickClean® QC6

Things to Consider

DESIGN CONSIDERATIONS BEYOND THE 5-STEP WORKFLOW				
CONSIDER	WHY THIS CONSIDERATION IS IMPORTANT	HOW TO SOLVE	MIDMARK SOLUTION	RATE IMPORTANCE <i>(scale of 1–3 where 1 is lowest and 3 is highest)</i>
 <p>Location Is your instrument processing area centrally located?</p>	On average, your team may go in and out of the instrument processing area 80–120 times per day. A closer sterilization center means less time walking back and forth and more time with patients.	Consider centering your design around your sterilization center. Make sure the farthest operatory is no more than three operatories away.	Midmark Design Services (Call 1.800.MIDMARK)	
 <p>Showcasing safety Do your patients know how you're keeping them safe?</p>	A well-designed sterilization center is not just an engine of productivity for your practice, it can be a valuable marketing tool to reassure your patients how much you care about their safety.	Consider your equipment, space and workflow to create a safety showpiece. Consider adding a glass window so patients can see how you're keeping them safe.	Midmark Design Services (Call 1.800.MIDMARK)	
EQUIPMENT CONSIDERATIONS				
CONSIDER	WHY THIS CONSIDERATION IS IMPORTANT	HOW TO SOLVE	MIDMARK SOLUTION	RATE IMPORTANCE <i>(scale of 1–3 where 1 is lowest and 3 is highest)</i>
 <p>Number of clinicians Is your instrument processing equipment adequate to reprocess instruments for each clinician's patient load?</p>	If you don't have enough equipment capacity for instrument processing, it can slow down your practice and increase labor costs.	Consider how many clinicians work in your practice to help determine the right equipment sizes and quantities. See the "Choose the Right Capacity" chart on page 17 for details.	QC3 or QC6, Midmark M9® or M11® Sterilizers	
 <p>Handpiece maintenance What is your solution for cleaning and lubricating your handpieces? Is it simple and efficient?</p>	Handpieces require special cleaning and lubrication. Performing this care and maintenance manually can be time-consuming and lead to inconsistent results.	Consider adding a handpiece cleaning and lubrication device to your sterilization center for consistent, repeatable and thorough results.	Lubricare 2® Handpiece Care and Maintenance System by Bien-Air®	
 <p>Cassettes vs. Pouches Do you use cassettes?</p>	Cassettes help you process more instruments than pouches in one load. For their greater capacity and larger dimensions, cassettes require larger cleaners and sterilizers.	Consider ultrasonic cleaners of at least 3 gallons, sterilizers with a chamber of at least 11-inches and a vertical cassette rack for better drying in your sterilizer.	QC3 or QC6, Midmark M11® Sterilizers and Optional Vertical Cassette Rack	
 <p>Monitoring Is your team consistently documenting and monitoring results in your sterilization records?</p>	The CDC and ANSI/AAMI organizations recommend mechanical, chemical and biological monitoring of your sterilizers to ensure the equipment is operating properly for patient safety.	Consider simplifying monitoring with a sterilizer that automatically captures routine care events and cycle information.	Midmark M9® or M11® Sterilizers	
 <p>Total cost of ownership Have you considered how much your sterilizer maintenance is costing you?</p>	You could spend as little as ~\$200 per year or as much as ~\$2,000 per year depending on the technology you select. A sterilizer that uses a vacuum requires a daily air removal (Bowie-Dick) test and documentation of the results. Some sterilizers also require air and/or water filtration accessories that you will have to maintain and replace.	Consider a sterilizer that requires no additional air or water filtration accessories or expensive daily Bowie-Dick tests.	Midmark M9® or M11® Sterilizers	

Midmark[®] Products + Solutions



▶ Instrument Processing Solutions



▶ Instrument Processing Product Specifications



▶ Midmark Steam Sterilizers "What Makes Them Different?" Video

Lubricare 2[®] by Bien-Air[®]

DENTAL HANDPIECE CARE + MAINTENANCE SYSTEM

Increase handpiece longevity by completing 3 essential processes after each use: Cleaning, Lubricating and Sterilizing. Rely on Lubricare 2's clean-air blowing system to thoroughly clean inside your handpieces and standardize internal lubrication. With an automated system, you can ensure consistent, repeatable high standards without the variability that may occur when performing these processes by hand. Complete handpiece maintenance with simplified sterilization in a Midmark M9[®] or M11[®] sterilizer.

Bien-Air's Spraynet[®] cleaning solution can reduce 99.99% of the microbial load inside your handpieces.



- 01** Use Bien-Air's Spraynet[®] cleaning solution and Lubrifiuid[®] lubricant to maintain impeccably hygienic instruments with an unrivaled service life.
- 02** Clean a turbine in approximately 20 seconds and a contra-angle handpiece in 40 seconds with preprogrammed operating modes that enable automatic maintenance.

- 03** Reduce oil consumption with a more consistent process than manual maintenance.
- 04** Dispense cleaner and lubricant separately with the Lubricare 2 to achieve more precise application than systems that dispense these solutions together.



STREAMLINE HANDPIECE CARE

Improve workflow when you combine Bien-Air electric handpieces with the Lubricare 2 system and Midmark sterilizers, which have two cycle presets that align directly with Bien-Air handpiece cycle requirements.

QuickClean[®] Ultrasonic Cleaners

Cleaning is the critical first step in the 5-step instrument processing workflow and is necessary to remove contaminants before sterilization. If an instrument is not clean, it will not become sterile. The QuickClean Ultrasonic Cleaner can eliminate microscopic and hard-to-see debris manual cleaning may miss while decreasing exposure to contaminants and helping protect your team from potential sharps injuries.



Frequency LEAP technology helps clean instruments thoroughly and consistently throughout the entire bath.

- Choose from three countertop QuickClean sizes—1.2, 3.3 or 6.6 gallons—or two recessed QuickClean sizes—3.3 or 6.6 gallons.
- Accommodate your cassettes with the 3.3 or 6.6-gallon QuickClean size options.
- Receive alerts when the fluid sensor detects insufficient water level in the bath.



- Follow prompts displayed on the digital LCD control panel for easy operation.
- Retain previous cycle settings with options for preset or customized settings, along with built-in data storage.

Fully clean instruments the first time, every time—no matter where they are placed in the basket.



01

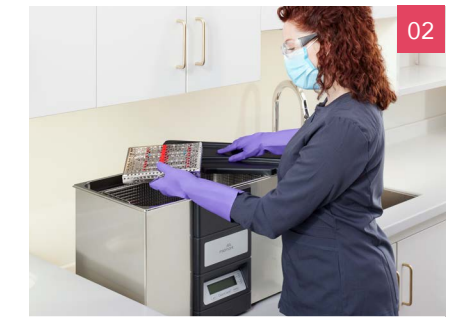

02



03



04



05

- 01** Set up and operate your QuickClean Ultrasonic Cleaner right out of the box and be up and running with minimal installation and training time.
- 02** Select between a countertop or recessed model QuickClean and receive a 3-year limited warranty.

- 03** Use glass beakers to clean very small items. Even though the items are inside the beaker, ultrasonic waves can still reach and clean them. Choose from a 2-beaker, 4-beaker or 6-beaker kit.
- 04** Restock your required cleaning solutions with Midmark General Purpose Cleaner, Tartar and Stain Remover, and Enzymatic Cleaner; each available in 32 oz bottles.

- 05** Always put instruments in a safety basket (or beaker) to avoid damage to the machine and/or instruments. Extra baskets are available for each QuickClean model in addition to the included basket.

Midmark M9[®] + M11[®] Sterilizers

MIDMARK STEAM STERILIZERS

Reduce stress and get your team back to the work they love with intuitive sterilizer technology. Midmark Steam Sterilizers are designed to enhance workflow, compliance and durability, offering an increased cycle life of 25,000 cycles thanks to a completely re-engineered chamber.



Proudly designed, assembled and supported in the USA.

CYCLE	INITIATED	STATUS
07/09/2024		
Wrapped Cycle 126 Load 8	02:07 PM	✓ →
Wrapped Cycle 125 Load 7	01:04 PM	⚠ →
Wrapped Cycle 124 Load 6	11:59 AM	✖ →

STREAMLINED COMPLIANCE RECORDKEEPING

Stay audit-ready with device reminders and notifications, user authentication, unlimited storage of routine care events for the life of the sterilizer, and automated cycle recordkeeping.

Help save time, simplify teammate training and build instrument processing confidence with automated mechanical monitoring and chemical indicator reporting.



01



02

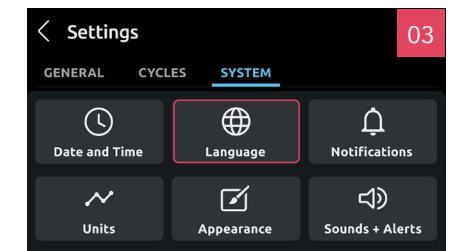

03

01 Navigate cycle setup and other processes with a clear, fingerprint-resistant 5-inch touchscreen you can utilize while wearing gloves. Choose a style—light or dark mode.

02 Determine cycle status—cycle in progress, cycle complete and cycle error—from a distance with a progressing color-coded LED light bar, large cycle-countdown clock and audible cues.

03 Operate in your preferred language with display options of English, French or Spanish (French and Spanish available with a future software update).

STRESS-REDUCING TECHNOLOGY

Midmark sterilizers are designed for an intuitive user experience.

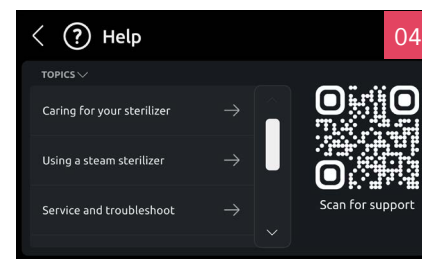
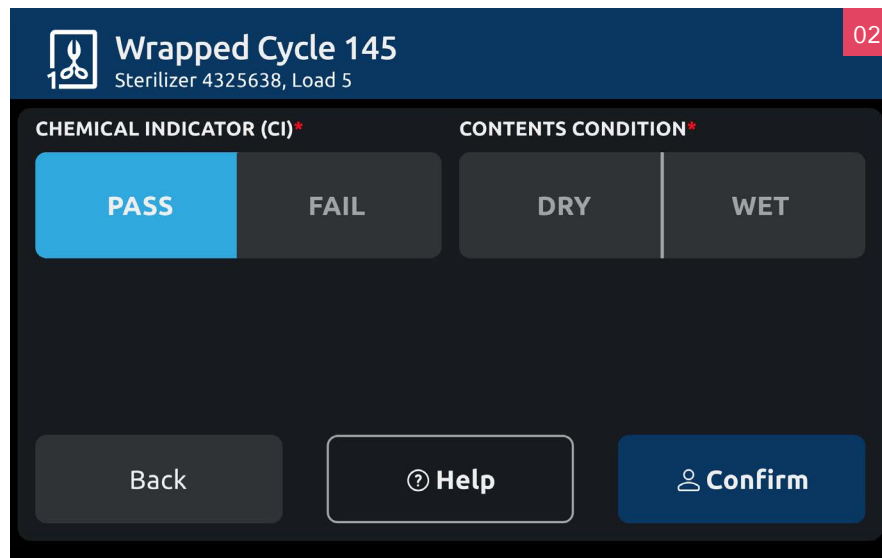

- 01 Simplify compliance documentation with electronic notifications, unlimited storage of routine care events for the life of the sterilizer and automated cycle records.
- 02 Streamline sterilization with touchscreen prompts that lead your team through a standardized process.

- 03 Easily track users with authentication settings.
- 04 Reduce the burden of training with on-device step-by-step tutorials.

05



WRAPPED
270°F, 4 MIN



WRAPPED
275°F, 3 MIN



DELICATE
250°F, 30 MIN



UNWRAPPED
270°F, 3 MIN



5 CUSTOM CYCLES*
250°F–275°F, 3 MIN–45 MIN

- 05 Simplify clinical workflow with dynamic-air-removal steam sterilizers that provide unique preset cycles to meet both the CDC⁸ and AAMI⁹ sterilization cycle recommendations for wrapped instruments.

*Custom cycles are not FDA-cleared, and validation of the sterility of items processed using a custom cycle is the responsibility of the user.

8,9 See inside back cover for details and sources



INCLUDED IN THE BOX



PROTECT YOUR INVESTMENT

Register your warranty at midmark.com/protectyourinvestment to receive prompt support when you need it and opt in to receive future notifications for available software updates.

THE FOLLOWING COMPONENTS ARE INCLUDED WITH EACH STERILIZER SHIPMENT.

- A. Speed-Clean Sterilizer Cleaner** – One bottle of Speed-Clean is included with each sterilizer purchase. Use this cleaning solution during weekly and monthly sterilizer maintenance.
- B. Manuals** – The Setup and User Guide, Care and Operation quick reference, and Speed-Clean SDS (Safety Data Sheet) are included in each purchase.
- C. Pouch Rack** – One 5-slot rack is included with the M9[®] and one 6-slot rack is included with the M11[®]. Racks separate sterilization pouches for enhanced steam circulation and drying.
- D. Power Cord** – The power cord is included detached from the unit. Follow your sterilizer's instructions for use when connecting the power cord to your sterilizer.
- E. Large, Lightweight Trays** – Two small trays and two large trays are included with each sterilizer purchase.

ACCESSORIES



Cool Hand Tool

This tool connects to trays and cassettes to help reduce the risk of team injury while loading or unloading the sterilizer.

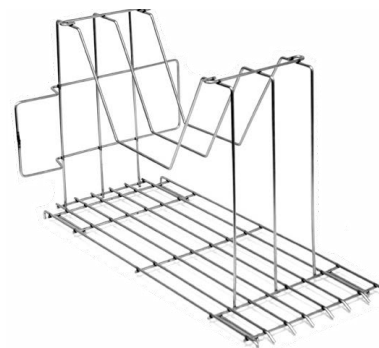

Vertical Cassette Rack

For use with the M11[®], this rack can hold up to four 8" x 11" cassettes and four 3" x 8" cassettes together, or twelve 4.5" x 8" cassettes.

ACCESSORIES (CONTINUED)



USB Kit

Download cycle records including time, temperature and pressure. Includes USB drive, USB cable and PC board (technician installation required).

OPTIONAL WATER MANAGEMENT SYSTEMS



Autofill

The optional autofill accessory (left) can be paired with your choice of water filtration system (right) to limit user intervention and use fresh water with every cycle.



Water filtration system is not sold by Midmark.

Auto-Drain

The optional VistaCool™ Direct-to-Drain System for Autoclave Wastewater reduces the temperature of sterilizer wastewater before sending it directly and safely to the drain. This non-electric, self-monitoring and self-regulating system frees your team to spend more time chairside and less time maintaining equipment.

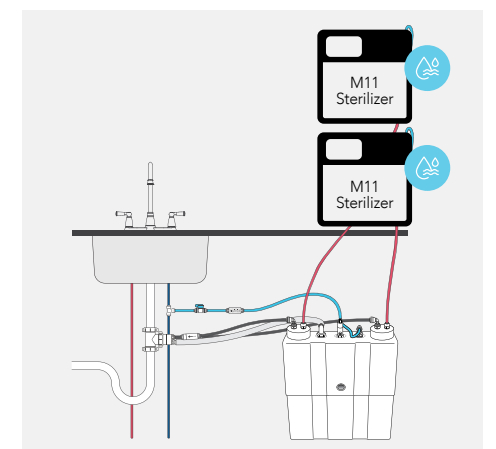
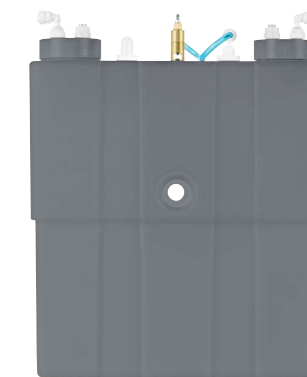



Clinical-Grade Cabinetry for Your Sterilization Center

Both Synthesis® and Artizan® Expressions Midmark cabinetry collections are specifically designed for the rigors of the healthcare environment and crafted to fit your space and workflow. Durable construction and aseptic surfaces stand up to the water, steam and heavy use of the sterilization area to provide a lifetime of usability. **Because your practice is a specialized treatment facility, you need solutions designed for dentistry.**



SYNTHESIS® CABINETRY



ARTIZAN® EXPRESSIONS CABINETRY

Synthesis[®] Sterilization Center Cabinetry

"Strong yet stylish, the steel Midmark cabinetry line [Synthesis] was the right choice for my new office. With well-thought-out functionality in a contemporary design, it shows every patient that our office invests in the absolute best for their care."

Dr. Brian S. Nylaan
Grand Rapids, MI

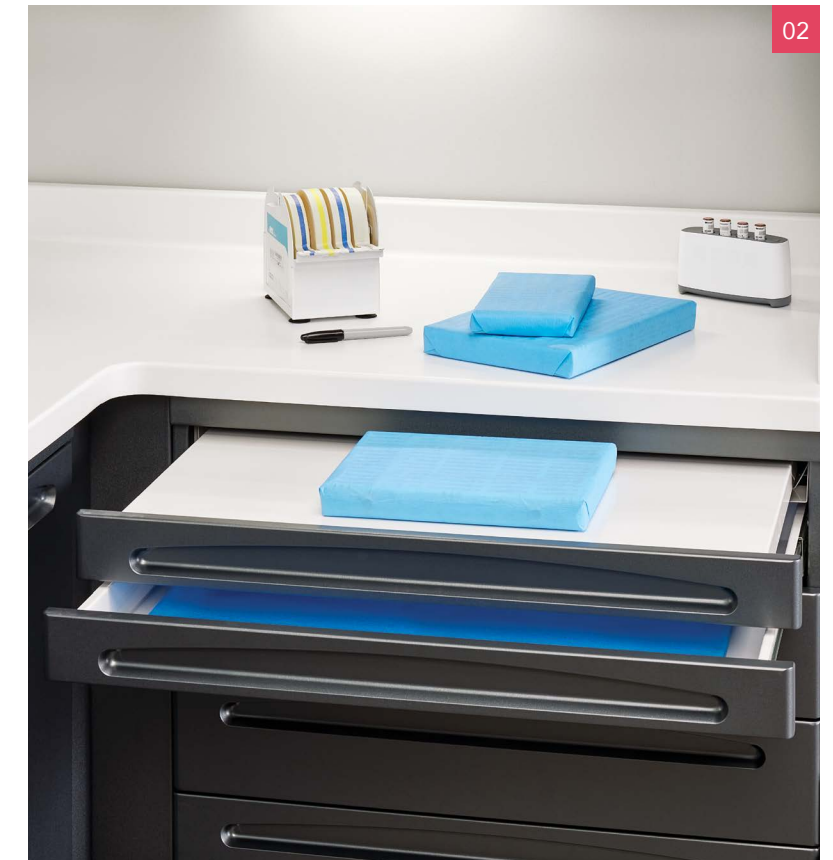

01 A temporary holding compartment provides dedicated storage for soiled instruments prior to processing. Red-illuminated windows indicate a dirty environment.

02 Wrap station drawers provide additional counter space in the preparation and packaging area.

03 Gravity-fed angled flow-shelving improves visibility and accessibility to supplies and materials, even for items stored at the back.

04 Slide-out shelves utilize solid-surface Corian[®] drainboard surfaces for durable, strong, moisture-resistant sterilizer support up to 200 lb.



Contributing to satisfying the LEED[®] Green Building Rating System, the steel frame of Synthesis Cabinetry provides the durable structure and aseptic design required for a long product life, even in the harsh and demanding environment of a sterilization center.

Artizan® Expressions Sterilization Center Cabinetry

"The unique design of the Artizan Expressions cabinetry line sets my office apart from others with traditional dental cabinetry. Midmark has also done a great job with the ergonomic storage and overall function of the cabinetry, they've thought of it all!"

Dr. Reza Nazari
Granada Dental, Livermore, CA



Artizan Expressions brings a sleek, modern look to the dental space. We believe "best is standard" and use only quality components and materials on every cabinet we build.

- 01** Durable steel-frame construction delivers long life and consistent drawer and door performance. Drawer dividers provide the next level of organization for a better, more efficient workflow.
- 02** Heavy-duty solid Corian® slide-out shelves in the sterilization tower cabinet provide easy access to your equipment.

- 03** The storage pantry slides out, allowing easy access to adjustable baskets. Blue-illuminated windows indicate a clean environment.
- 04** Trash-drop options, including a hands-free air-glide system, help minimize cross-contamination.

Synthesis[®] Cabinet Finishes

Synthesis door and drawer panels are sealed with membrane-pressed thermofoils in woodgrain and metallic colors. Thermofoil is a dimensionally flexible material that provides a continuous seamless surface, eliminating the need for panel edgework and offering a high level of scratch and stain resistance.



Artizan[®] Expressions Cabinet Finishes

Available in a variety of Arauco[®] and Formica[®] colors, Artizan Expressions uses thermally fused melamine panels. These panels are created at high temperature and pressure to form a durable, peel-resistant finish. Matching edgework is applied to completely seal the corners from moisture.



Handle + Panel Style Options

HANDLE STYLES



PANEL STYLES



*EPA Registration Number 85353-2

HANDLE STYLES

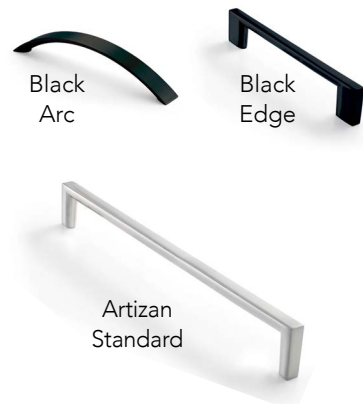

PANEL STYLE



Countertop Colors

Solid Surface (SS) is a unique material made from an advanced blend of natural minerals and acrylic polymer. It has proven itself to be a remarkably durable, versatile material that's an ideal surface for dental environments. **Quartz (Q)** is virtually maintenance free and, because it is one of nature's strongest materials, it is also incredibly durable, exceptionally tough and scratch resistant.

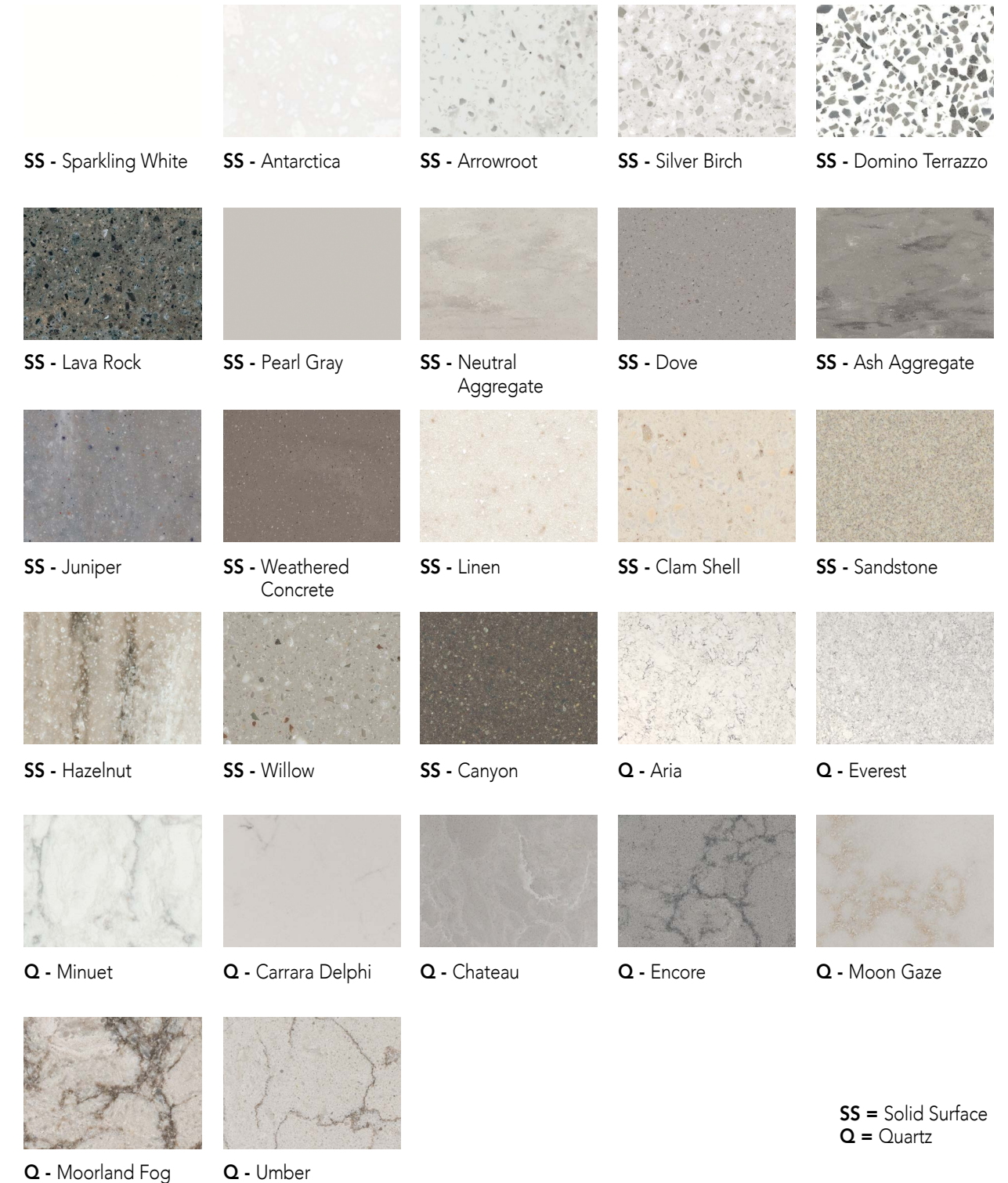











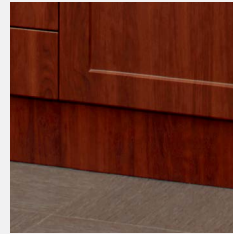
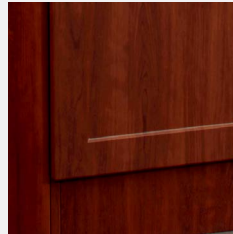



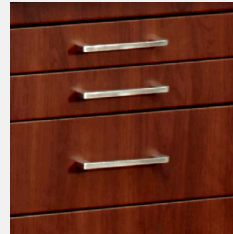



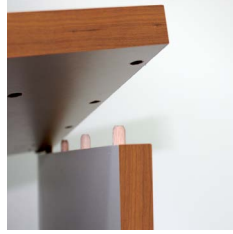

SS = Solid Surface
Q = Quartz

Compare Quality

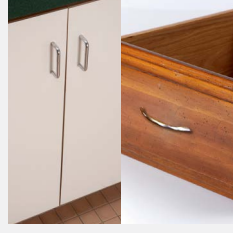
MIDMARK® CLINICAL-GRADE CABINETRY VS. CONSUMER-GRADE CABINETRY

Most generic or local cabinetry is not designed for the demanding dental environment. Consumer-grade cabinetry can delaminate over time, develop unsealed corners susceptible to bacteria and moisture, and warp from the humidity inherent in a dental practice.

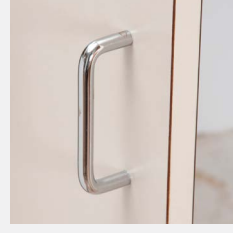
	CABINET FRAME	PANEL SUBSTRATES	BASE MATERIAL	FINISHES	TYPES OF ASSEMBLY	DRAWERS	DRAWER SLIDES	HANDLES
<p>MIDMARK SYNTHESIS® CABINETRY</p> <p>A steel foundation provides strength and durability.</p> <ul style="list-style-type: none"> 18-gauge cold-rolled steel Modular design 	 <ul style="list-style-type: none"> 18-gauge cold-rolled steel Modular design 	 <ul style="list-style-type: none"> Medium-density fiberboard 3/4" panels 	 <ul style="list-style-type: none"> Thermofoil over electrostatic, powder-coat painted steel (woodgrain and metallic colors) Electrostatic, powder-coat painted steel (solid colors) Integrated adjustable levels 	 <ul style="list-style-type: none"> PVC thermofoil (woodgrain and metallic colors) PVC thermofoil and electrostatic, powder-coat paint (solid colors) 	 <ul style="list-style-type: none"> Mechanical fasteners (screws, pop rivets) Tog-L-Loc® sheet metal joining system <p>Mechanical fasteners and Tog-L-Loc provide reliable strength.</p>	 <ul style="list-style-type: none"> Seamless, one-piece polystyrene <p>Seamless polystyrene drawers with rounded corners contain spills and simplify cleaning.</p>	 <ul style="list-style-type: none"> Full-extension ball bearing drawer system Steel mounting foundation Soft-close feature 	 <ul style="list-style-type: none"> Integrated and insert options Brushed nickel options Antimicrobial option <p>Synthesis pull options support an aseptic environment.</p>
<p>MIDMARK ARTIZAN® EXPRESSIONS CABINETRY</p> <p>Industrial-grade strength prolongs durability.</p> <ul style="list-style-type: none"> 3/4" industrial-grade particle board Customizable design that can be configured to specific requirements 	 <ul style="list-style-type: none"> 3/4" industrial-grade particle board Customizable design that can be configured to specific requirements 	 <ul style="list-style-type: none"> Industrial-grade particle board 3/4" panels 	 <ul style="list-style-type: none"> Seamless stainless steel Integrated adjustable levels 	 <ul style="list-style-type: none"> Factory pre-applied, thermally fused melamine 3 mm PVC edgebanding 	 <ul style="list-style-type: none"> 100% glue-dowel assembly <p>Glue-dowel assembly adds strength to the frame.</p>	 <ul style="list-style-type: none"> Wood bottom and backs using factory, pre-applied thermally fused melamine Metal slides with front panel adjustment and removal feature 	 <ul style="list-style-type: none"> Full-extension ball bearing drawer system Soft-close feature 	 <ul style="list-style-type: none"> Brushed nickel <p>Brushed nickel pulls are easy to clean for better asepsis.</p>
<p>CONSUMER-GRADE CABINETRY*</p> <p>Millwork options are not specifically designed to endure the clinical dental environment.</p> <ul style="list-style-type: none"> 1/2" to 5/8" low-density particle board or plywood (typically) Basic or limited design 	 <ul style="list-style-type: none"> 1/2" to 5/8" low-density particle board or plywood (typically) Basic or limited design 	 <ul style="list-style-type: none"> Low-density particle board Plywood 	 <ul style="list-style-type: none"> Basic plywood or particle board covered with laminate Wood shims for leveling 	 <ul style="list-style-type: none"> High-pressure laminate – Not always properly applied – May use low-grade substrate material Less than 2 mm edgebanding Varnish, paint, or left unfinished 	 <ul style="list-style-type: none"> Staple fasteners (frequently) <p>The staple fasteners typically used in consumer-grade millwork are unreliable for clinical-grade cabinetry.</p>	 <ul style="list-style-type: none"> Insides often varnished, painted or unfinished <p>Seams and sharp inner corners can result in difficulty cleaning and a build-up of contaminants.</p>	 <ul style="list-style-type: none"> Single, undermounted runner (monorail glide—typically used) Slides common in kitchens (less durable) 	 <ul style="list-style-type: none"> C-style shape Plastic or aluminum <p>Consumer-grade millwork pulls are not made to support an aseptic clinical environment.</p>

See What Our Customers Are Saying

“Our speed of workflow has really increased. We’re able to turn over instruments faster. We’re able to get patients into rooms faster. We’re able to see more patients and treat them better with our new design.”

Krystal Gillis, DDS
Gillis Family Dentistry

“Safety is our best marketing tool. When we designed our office, we put a large window in our sterilizing room. People asked why we wanted patients to see dirty instruments. Easy—we want them to see how effectively we practice and trust that everything is completely sterile for their safety.”

Dr. Ileana T. Toro, DMD
Dr. Junot J. Franco, DMD
Village Park Advanced Cosmetic and Family Dental

“My team says sterilization is easier than ever and that the implementation of the new Midmark steri-center has increased efficiency and turnover time. The distinct flow and separation from dirty to clean have made an enormous impact on team confidence in sterilization protocol. There is a sense of ease that comes in knowing the instruments are kept in a sterile environment until the time of use.”

Robert J Stevenson, DDS
Ann Arbor, MI



Visit the Midmark Experience Center

A team of Midmark design experts are ready to help you personalize and equip your entire clinical environment from the layout of every room to each sterilizer, chair, door and drawer—down to the smallest detail. Let us help you bring your dental practice vision to life.

HOW IT'S CREATED

Check out our videos on how Synthesis and Artizan Expressions Cabinetry are made. See the quality and craftsmanship that go into each and every cabinet we produce.

midmark.com/synthesiscabinetry_creation
midmark.com/artizanexpressions_creation

DENTAL DESIGN TOOL

Our easy-to-use, life-like digital tool helps you find your individual style and visualize how your operatory and sterilization space will look.

midmark.com/designtool

SOURCES

- 1 Survey results from Direction Research for Midmark Corporation, 2022
- 2 HuFriedyGroup - <https://www.hufriedygroup.com/blog/your-dental-sterilization-area-setup-efficient-or-bottleneck>
- 3 HuFriedyGroup - https://www.hufriedygroup.com/sites/default/files/9697_IMS-3811_Selling_Guide_1214.pdf
- 4 Shah, S.M., Merchant, A.T. & Dosman, J.A. Percutaneous injuries among dental professionals in Washington State. BMC Public Health 6, 269 (2006). <https://doi.org/10.1186/1471-2458-6-269>
- 5 Midmark Research Survey Result
- 6 ADA - https://www.ada.org/-/media/project/ada-organization/ada/ada-org/files/resources/research/hpi/feb2023_hpi_economic_outlook_dentistry_report_main
- 7 CDC - https://www.cdc.gov/infection-control/hcp/disinfection-sterilization/sterilizing-practices.html?CDC_AAref_Val=https://www.cdc.gov/infectioncontrol/guidelines/disinfection/sterilization/sterilizing-practices.html
- 8 CDC - Table 7. https://www.cdc.gov/infection-control/hcp/disinfection-and-sterilization/steam-sterilization-cycle-times.html?CDC_AAref_Val=https://www.cdc.gov/infectioncontrol/guidelines/disinfection/tables/table7.html
- 9 FDA - Appendix C. Table 2. <https://www.fda.gov/media/80265/download>



► The Midmark Experience



Designing better care.®



CARB 93120.2 Phase 2 Compliant and TSCA Title VI Compliant

Arauco, Bien-Air, Corian, Formica, LEED, Lubricare 2, Lubrifluid, Spraynet, Tog-L-Loc and VistaCool are not trademarks of Midmark Corporation and are the sole property of their respective owners.

Visit midmark.com/dental/products for the most current colors and finishes available for each product. The color examples shown here are the best representation of the original material. Actual color may vary slightly. We strongly recommend that you contact Midmark Customer Experience at 1.800.MIDMARK to request a sample before placing your order.

Midmark is an ISO 13485 and ISO 9001 Certified Company. Certain products are not included. See the complete list at: midmark.com/ISO

For more information, contact your authorized Midmark distributor or call: 1.800.MIDMARK Outside the USA call: 1.937.526.3662 or visit our website: midmark.com

© 2024 Midmark Corporation, Versailles, Ohio USA.
Products subject to improvement changes without notice. Litho in USA.

007-10011-00 Rev H1 (6/24)

